

User Manual Book

Water Dispenser

Pietro Series
DD 65 L

MODENA

Thank you for your trust in choosing MODENA products for your household needs. With your satisfaction as our priority, we constantly aim to deliver stylishly designed products equipped with state-of-the-art technology to assist you in your daily activities.

This is your guidebook containing everything you need to know about our product. Please reach out to us if you need further assistance or other information via our Customer Care or our official website www.modena.com.

MODENA

CONTENTS	PAGE.
• Introduction	2
• Part 1 : Name of Parts	4
• Part 2 : Installation	5
• Part 3 : How to Use	6
• Part 4 : Maintenance	6
• Part 5 : Precaution Action	6
• Part 6 : Troubleshooting	8
• Part 7 : Specification	9

Part 1 : Name of Parts

DD 65 L

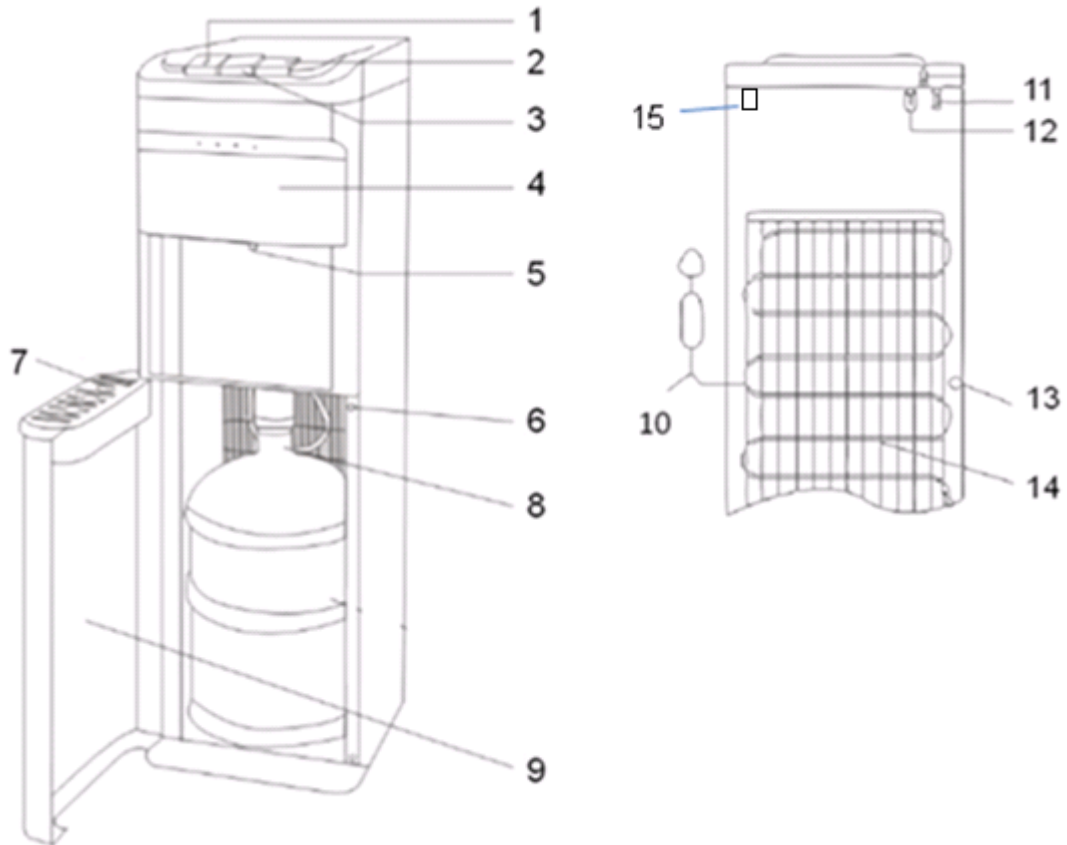

* Features and specifications depend on the type of product.

Note:

- | | | |
|--------------------------|------------------------|----------------------|
| 1. Hot Water Button | 6. Reset Button | 11. Cooling Switch |
| 2. Cold Water Button | 7. Drip Tray | 12. Heating Switch |
| 3. Normal Water Button | 8. Water Pipe | 13. Drain Valve |
| 4. Indicator/front panel | 9. Bottom Cabinet Door | 14. Condenser |
| 5. LED light | 10. Power Cord | 15. LED Switch Light |

Part 2 : Installation

Please read this operation manual carefully before operating the appliance in order to use the appliance properly and safely. Pay attention to the entire sign or warning explained on the pictures or text.

1. Install the dispenser on an even and stable surface. A minimum distance of 20 cm from the wall must be provided.
2. Leave it for 1 hour to stabilize the refrigerant.
3. Insert the pipe into the gallon and then cover it with the lid.
4. Insert the gallon into the cabinet and close the door.
5. Connect the power cord to the power socket, and turn on the red switch (heater) located behind the appliance. Make sure that the socket/electric source has been grounded to prevent electric leakage. Turn on the switch located behind the appliance.
6. **For initial use, the inside of the appliance must be cleaned. Press the hot and cold water button. Make sure the water dispenses out of the tap. After that, wait around 20 minutes, then remove the gallon out of the storage and empty the water by opening the drain valve. Make sure the power cord is unplugged from the power source when draining the remaining water.**

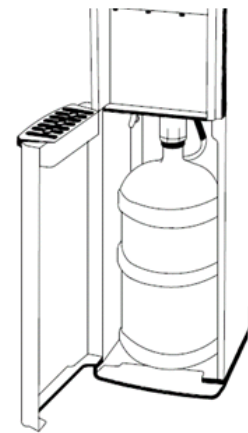
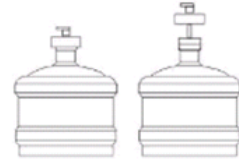

Attention :

- This appliance is designed for indoor use.
- Make sure the pipe is installed properly and the cabinet doors closed securely
- When the water in the gallon is empty, turn off the red switch (heating) before replacing it with a new one.
- Avoid placing the appliance in a humid, wet and poor electrical installation because it can cause an electric shock or fire.
- Do not place flammable objects near the dispenser.
- Do not expose the appliance to direct sunlight and rain because it can degrade its performance and cause electrical leakage hazard.
- Do not connect this dispenser to the source of electric current or pressing the heating button if there is no water in the tank or no water flows from the hot water tap if the button is pressed.
- Do not modify the power cord on the appliance or connect using extension cord to prevent risks of short circuit and fire.
- Do not touch the back or the condenser to avoid electric shock.
- During a power outage, after the power returns, wait around 5 minutes before turning the appliance on.

Part 3 : How to Use

How to use a dispenser with three taps:

- To dispense the hot water, push the left button.
- To dispense the normal-temperature water, push the middle button.
- To dispense the cold water, push the right button.

The appliance is equipped with a safety on hot water button to prevent the danger of the reach of children. Scroll and press the button to dispense hot water.

If the red indicator light is on, it indicates that the process of heating water is running. If the blue indicator light is on, it indicates that the process of cooling water in the tank is running.

If the yellow indicator light is on, this indicates the gallon water is empty. Replace with a new one immediately. The indicator light will turn off when the new galon is replaced. The appliance will run normally.

Attention:

- Beware! Avoid hazard of hot water.
- Cabinet door should be closed. If not, the pipe will not work out.



Part 4 : Maintenance

1. In order to avoid unwanted incidents, always disconnect the power cord from the power source before cleaning the dispenser.
2. This dispenser has been disinfected prior to shipping.
3. Water pipe, water tank, and heating element must be cleaned by expert technician once a year to maintain the machine to its good condition and to extend the appliance's lifespan. Do not attempt to disassemble the machine in order to avoid damage to the machine.
4. Use soft and wet cloth to clean the surface of the dispenser. Use soft and dry cloth to dry the surface. Do not let water enter the appliance's engine.
5. Make sure the power cord is unplugged from the power source when draining the remaining water or when in a maintenance or when not in use for a long time. Meanwhile, when the water from the hot tap is cold, open the drain valve until there is no water in the appliance.

Part 5 : Precaution Action

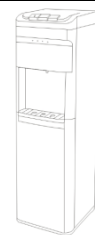
1. Install the dispenser on even surface. Avoid placing it in a humid place. A minimum distance of 20 cm from the wall must be provided. Do not store flammable substances near the dispenser.

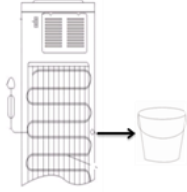
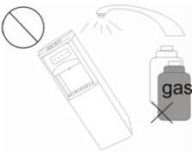
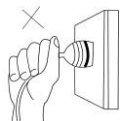
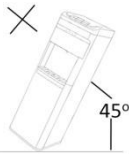
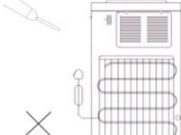

<p>2. To avoid damage to the machine, avoid connecting electrical cord or pressing the heating switch (red) until the hot water comes out of the hot water tap.</p>	
<p>3. If the dispenser won't be used for a long period, turn off the heating and cooling switches and disconnect the cord from the power socket and drain the remaining water through the drainage.</p>	
<p>4. Do not use chemical substances or directly pour water to clean the dispenser. Use soft cloth instead.</p>	
<p>5. Do not pull the cord to disconnect the power cord from the power socket. Hold and unplug it from the head with dry hand.</p>	
<p>6. Do not put the dispenser upside down. The inclination should not be more than 45° to avoid damage to the compressor.</p>	
<p>7. The thermostat on the dispenser has been adjusted by the manufacturer. Do not attempt to modify the thermostat by yourself to avoid unwanted damage.</p>	
<p>8. This appliance is designed for use by adults. Do not allow children to play with the appliance or let them hang on the door. The appliance may fall over and harm them. The appliance is not intended for use by individual (including children) with reduced physical, sensory or mental capabilities, or lack of experience and knowledge, unless they have been given supervision or instruction concerning the use of the appliance by a person who is responsible for their safety.</p>	

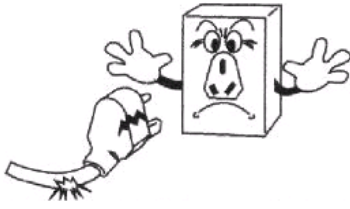

If there is damage to the power cord, contact MODENA Call Center immediately to do a replacement. The replacement of power cord must be done by experienced expert and understands about electricity. Never replace the power cord on your own, due to the dangers that could lead to harm yourself and others.



Attention!

This appliance must not be disposed of with other household waste. To prevent possible harm to the environment or human health from uncontrolled waste disposal.

The appliance contains a gas insulation and refrigerant that must be disposed of properly. When you want to dispose of the appliance, We advise you to consult with authorized service providers so that they can learn information required and official forms.

Make sure the pipes and duct work of refrigerant of the appliance is not damaged before it was taken by the disposal personnel.

Consult with authorized service providers to ask everything and issues regarding the appliance. Do not do or allow others to do anything to the appliance before asking the official service providers.

Part 6 : Troubleshooting

Please check these following before contacting the Call Center if any problem occurs:

<i>Problem</i>	Possible Cause	Recommended Action
Water is not hot or not cold.	<ul style="list-style-type: none"> - Excessive usage of hot water or cold water in a short period of time. - The appliance is not yet connected to electricity. 	<ul style="list-style-type: none"> - Wait until the water becomes cold or hot. - Connect the cord to the power socket and press the heating and cooling switches.
Water is not being dispensed out of the tap.	<ul style="list-style-type: none"> - Water gallon is empty. - The pipe is stuck or blocked something. 	<ul style="list-style-type: none"> - Replace the water gallon with a new one - Turn off the cooling switch. After 4 hours, turn it back on.
Leak on the water gallon support.	<ul style="list-style-type: none"> - Water gallon is leaking / damaged. 	<ul style="list-style-type: none"> - Replace water gallon with a new one.
Loud noise during operation.	<ul style="list-style-type: none"> - Improper installation or placement of appliance. 	<ul style="list-style-type: none"> - Install appliance on even and stable surface.
Buzzer is still ringing after changing the water gallon	<ul style="list-style-type: none"> - There is a problem with the reset button 	<ul style="list-style-type: none"> - Unplug out the power cord then plug in again.

Part 7 : Specification

MODEL	DD 65 L
Type	Cold, Hot & Normal
Bottom Loading	Gallon storage
Color	Black
Hot water output (liter/hour)	2
Cold water output(liter/hour)	1.5
High temperature (Celsius)	≥90
Cold temperature (Celsius)	≤10
Free-CFC compressor	Yes
Regulator of thermostat	Yes
Water tube material	Stainless
Heating Power (watt)	190
Compressor power (watt)	80
Product Dimension (L x W x H) mm	325 x 370 x 1040
Product weight (Kg)	15

L= Black V= Silver R= Red D= Gold W =White

* Specifications of this appliance may change without prior notice to improve the quality of the product. Pictures in this manual are schematic and may be different from the actual product. Values stated on the machine labels or in the documentation accompanying it are obtained in laboratory in accordance with the relevant standards. Depending on operational and environmental conditions of the appliance, values may vary.

