

User Manual Book Washing Machine

WT 1120 UFWH
WT 1120 UFGY

TABLE OF CONTENT

Part 1: Safety Information	4
Precautions	4
Environmental Notice	6
Part 2: Name of Parts	7
Installation	8
Horizontal Adjustment	8
Drain Hose Installation	9
Inlet Hose Installation	10
Part 4: How to Use	12
Precautions Before Washing	12
Before First Wash	12
Washing Instruction	13
Control Panel	16
Part 5: Maintenance	18
Cleaning & Maintenance	18
Cleaning the Lint Filter	18
Tub Clean	19
Cleaning the Inlet Valve	19
Part 6: Troubleshooting	19
Part 7: Specification	21

This guide book explains everything you need to know about your new product. Please contact our Customer Care should you need further assistance through www.modena.com.

PART 1: SAFETY INFORMATION

Read the user manual book carefully!

- Do not try to install or turn on the unit without having read the indicated safety precautions in this manual.
- Do not disassemble the electrical parts of this appliance. Any repairs done by an unauthorized person may cause serious injuries or properties incident.
- The adult should supervise the children in order to make sure the children can not play with the appliance.
- The appliance is not intended for use by persons(including children) with reduced physical, sensory or mental capabilities, or lack of experience and knowledge, unless they have been given supervision or instruction concerning use of the appliance by a person responsible for their safety.
- This appliance is intended to be household use only. Usage outside the intended use or excessive use may void the warranty.
- Do not modify the power cord. If the power cord is damaged, it must be replaced by technician with a replacement cable according to the appliance specification
- To avoid danger of suffocation, keep plastic bag away from babies and children.

Precautions

- Destroy the carton, plastic bag and other packing materials after the appliance is unpacked. Children might use them for play.
- Children require supervision when using the appliance
- Plug the appliance directly into the socket and ensure secure connection
- The unit requires proper grounding and the correct voltage
- An appropriate length of power cord is provided to reduce the risks of becoming entangled in, or tripping over a longer cord.
- Do not use an extension cord or plug adaptor. Failure may cause electric shock or risk of fire
- Choose a place that is near a grounded electrical socket.
- Do not place the appliance sitting over the power cord.

- Do not pull out or insert the plug with wet hands to avoid electric shock.
- Do not fasten, twist or tie the power cord. If the power cord is damaged, it should be replaced by the manufacturer, service technician or a qualified person to prevent any risk.
- Do not spill water directly onto the control panel
- Fix the drain pipe before use, make sure that the drain hole is not blocked
- Keep the unit in a dry place and away from direct sunlight. Do not place the machine on paper or foam. Do not place anything flammable beside this machine.
- When washing at high temperature, the door glass will get hot. Please do not touch the door glass, especially children.
- When the door needs to be opened in high temperature washing, please wait until the temperature drops to the safe temperature and the door lock is automatically unlocked.
- Please close the door when the washing machine is not in use to prevent children from entering the washing barrel.
- Please do not wash waterproof clothes, such as raincoats, down products, sleeping bags, etc.
- Only machine washable clothes can be washed. If in doubt, please follow the washing guide on the clothes.
- Do not wash or dehydrate the clothes stained with kerosene, gasoline, diluent and other flammable materials.
- When the power plug is pulled out, the door lock can be opened even if the water level in the barrel is high. Therefore, in any case, please confirm the water level in the barrel before opening the door. If the water level is high, please do not open the door to avoid unnecessary loss caused by water overflow
- Unplug the unit when the unit will not be used for a long period for the reason of saving electricity. Never use organic liquids polishing chemical to clean the machine.

Environmental Notice



The packaging material used is recyclable. We recommend that you separate plastic, paper and cardboard and give them to recycling agents. According to WEEE (Waste of Electrical and Electronic Equipment) guidelines, waste from electrical and electronic devices should be collected separately. If you need to remove of this appliance in the future, do not throw it away with the rest of your domestic garbage. Instead, please take the appliance to the nearest WEEE collecting agents, where available.

PART 2: NAME OF PARTS

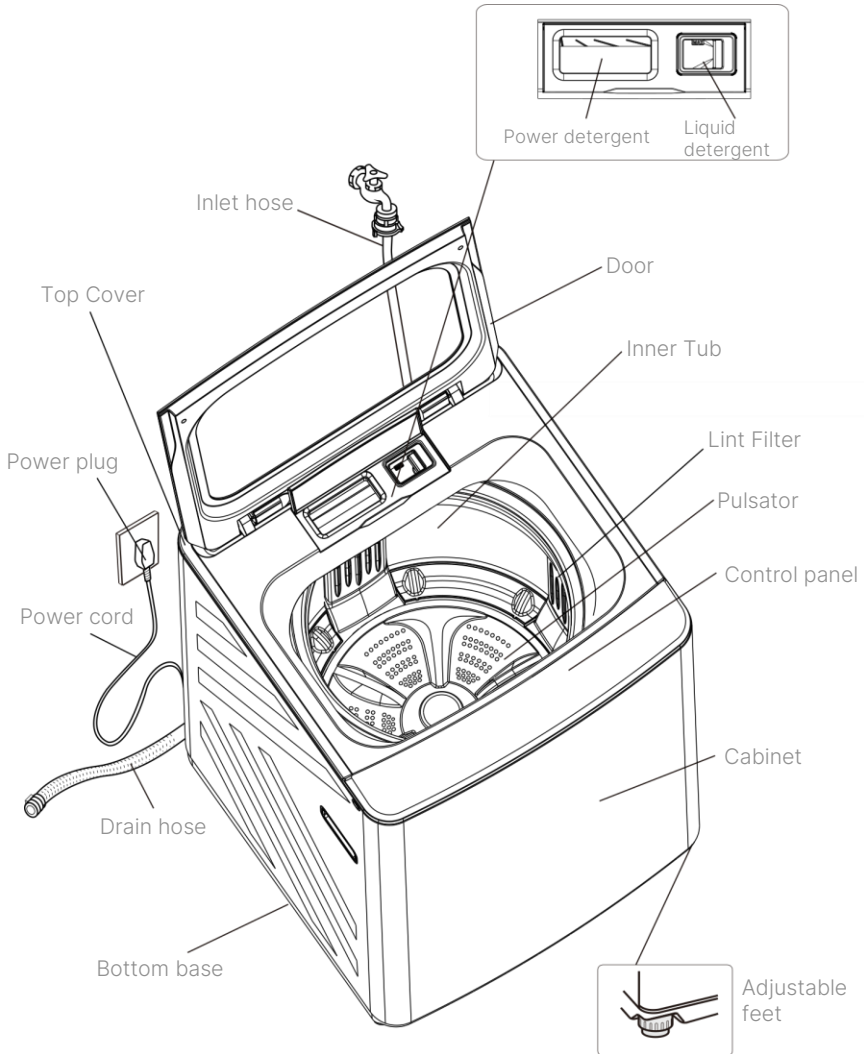

Above picture is for reference only. Actual product may have slight difference

PART 3: INSTALLATION GUIDE

Installation

- The appliance should not be installed in an environment below 0°C. Do not install or place the washing machine outdoors.
- Leave some space at least 10 cm between the appliance and the surrounding objects or wall
- Place the appliance on a sturdy flat surface
- Keep the appliance away from hot objects and water splashes.
- If there are many insects in the installation environment, please keep the surroundings of the washing machine clean. The warranty does not cover any damage caused by cockroaches or other insects.
- The appliance is equipped with anti-rat cover to protect the appliance from small animals like rats infiltration. Install the anti-rat cover on the bottom base of the appliance
- When installing the appliance, remove all packaging and the tub support base as shown in the picture. Failure to do so will hinder the appliance performance
- During first installation or first use, residual water may come out of the appliance. This is normal because the appliance was pre-tested in factory

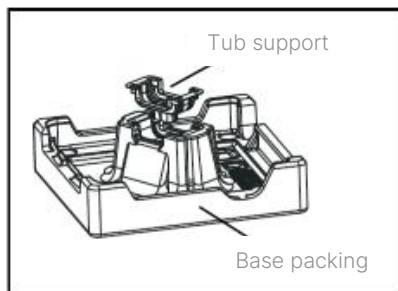

Horizontal Adjustment

- Adjust and level the appliance to prevent noise and vibration. Install on a sturdy flat surface (recommended place is on the corner of the room).
- If the surface is not flat, adjust the feet (do not insert foreign object such as a block of wood under the feet). Ensure that the appliance is level by using a leveling measurement device
- Adjust the feet until the appliance is level and lock the feet by tightening the nut
- Do not place the appliance on top of a desk to prevent the appliance from falling down

- Press the four top corners of the appliance, the appliance should not be able to wobble. If the appliance wobbles, readjust the feet
- The maximum recommended surface angle is no more than 2°.

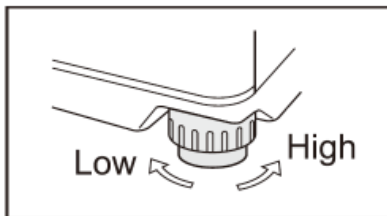

Drain Hose Installation

Before using the appliance, make sure the drain hose is properly installed

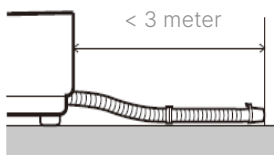

If the drain hose needs extension, the maximum length is 3 meters

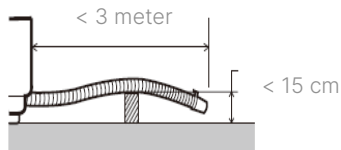

Maximum height of doorsill should be 15 cm

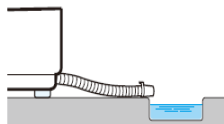

Drain hose shouldn't be immersed in water



Do not place the drain hose under the appliance (may cause damage to the drain hose)

Inlet Hose Installation

Faucet Types

Types of faucet that can and can't be used are as follows:

- Type A: This faucet is suitable for washing machine
- Type B: This faucet is suitable, however the front end should have minimum length 10 mm. The front end should be flat and smooth, otherwise it will cause leakage.
- Type C: This faucet is not suitable and may cause leakage

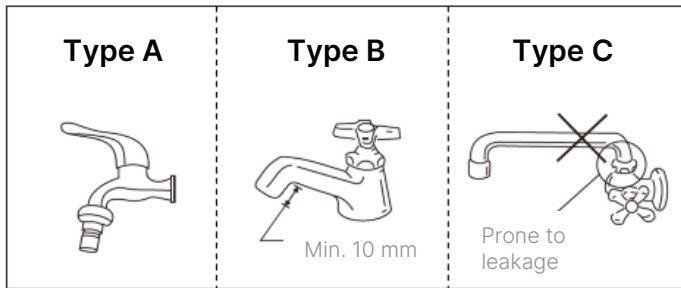

WARNING!

Use the inlet hose provided along with the appliance, your old inlet hose may not be used. If your faucet types are not suitable as above, replace the faucet first.

Water Faucet Connection

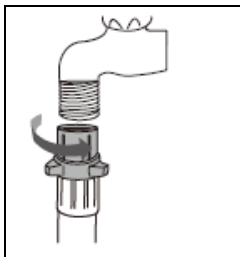

If your faucet has threads, the inlet hose can be installed directly by releasing the adapter and fit the connector the the faucet.

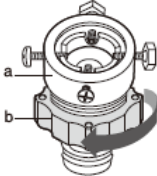
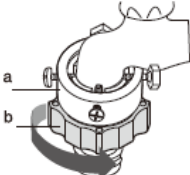
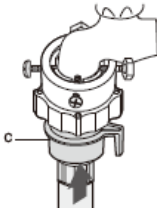
	<p>If your faucet do not have threads, use the provided adapter. Release the adapter from the inlet hose.</p>
	<p>Use philips (+) screw to loosen the 4 (four) screws of adapter (a). Unscrew the locking nut (b) so as there is a 5 mm gap between the nut and adapter.</p>
	<p>Insert adapter (a) to faucet end and tighten the 4 (four) screws. Tighten the locking nut (b).</p>
	<p>Install the inlet hose to the adapter by sliding and holding the part (c), insert the hose until you hear a click sound.</p>

WARNING!

After installing the inlet hose, check for leakage. If there's a leakage, repeat above steps until there is no leakage left.

Installing Inlet Hose to the Washing Machine

Connect the other end of inlet hose to the inlet valve located on the back of the washing machine. Tighten the locking nut.

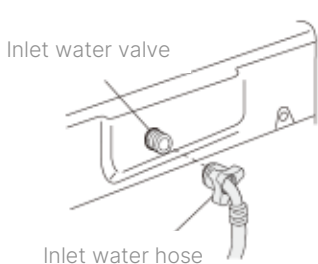

PART 4: HOW TO USE

Precautions Before Washing

1. Install the power plug to the main power socket
2. Make sure the inlet hose is installed properly and there is no leakage. Open the water faucet.
3. Make sure the drain hose is installed properly

WARNING!

This washing machine is not designed for hot water wash. Water inlet temperature should be less than 50°C

Before First Wash

Before using your appliance for the first time, perform a tub cleaning procedure:

1. Press POWER button
2. Insert detergent directly into the tub
3. Open water faucet
4. Press PROGRAM button, select TUB CLEAN program
5. Press START/PAUSE button
6. Wait until the program is finished and after that the washing machine is ready to use.

Washing Instruction

Sorting Laundry

Sort your laundry based on below criteria:

- Care Label: Sort your laundry based on cotton, mix, synthetic, silk, wool, and rayon
- Color: Separate white and colored clothes.
- Size: Mix different size items to maximize washing performance.
- Sensitivity: Follow the special instruction on the care label such as wool and silk to prevent damage to your clothes.

Empty the pockets

Check and empty the pockets of your laundry from:

- Metal objects such as coins, pins, belts, to prevent damage to the laundry and/or the tub
- Turn over clothes with buttons and embroidery
- Zipper from pants and jackets may damage the tub during the wash
- Clothes with zipper should be closed and tied
- Clothes with long tails or ropes may tangle with other clothes. Make sure to tie the tail or rope before washing.

Washing Net or Separate Wash

Use washing nets or separate the wash cycle for several clothes such as:

- Bra (water washable types) should use washing net. Metal objects on the bra can damage other clothes.
- Cashmilon and other big and light clothes (lacy clothes, underwear, nylon stocking, synthetic fiber) can float, be damaged, and cause problems to the washing machine. Use washing nets or wash separately
- Do not wash empty nets. This can cause abnormal vibration that can displace the washing machine and cause injuries

Pre-Wash (if needed)

For maximum washing performance, clean heavily soiled clothes before inserting them into the washing machine.

- To clean soil on collars, arms, folds, and pockets, pour a little amount of detergent and brush.

- Use powder or liquid detergent. Do not use soap, it can leave residue to the tub
- Wash white socks and white clothes with detergent and brush them.

WARNING!

Make sure the laundry is completely inside the tub. Scattered laundry can cause damage to the clothes and appliance. Make sure the clothes do not exceed the tub height.

Determine the wash capacity

This washing machine can wash as declared on the label or manual book. The declared capacity is for dry cotton clothes.

WARNING!

If you wash bed sheets or bed cover, the washing time may be longer or the spin efficiency may decrease. For sheets and blankets, recommended laundry weight is less 3.5 kg

Selecting Detergent

Detergent types may differ according to the clothes material, color, temperature, and soil level. Always use low foam detergent designed specifically for automatic washing machine.

- Use enough detergent. Excessive amounts of detergent do not improve the washing result, but do damage to the laundry due to reduced rinsing performance.
- Bleach is a strong alkali, which causes damage or discoloration of the laundry.
- Use an increased or longer rinse cycle when using powder detergent which is likely to remain on the laundry and create an unpleasant odor after the wash is finished.
- If an excessive amount of detergent is used, especially in cold water, it may not dissolve completely, leading to contamination of the laundry, hoses and/or tubs.

WARNING!

Do not use detergents which tend to solidify or solidify. Such detergent will remain after the rinse process, blocking the drain opening.

Control Panel

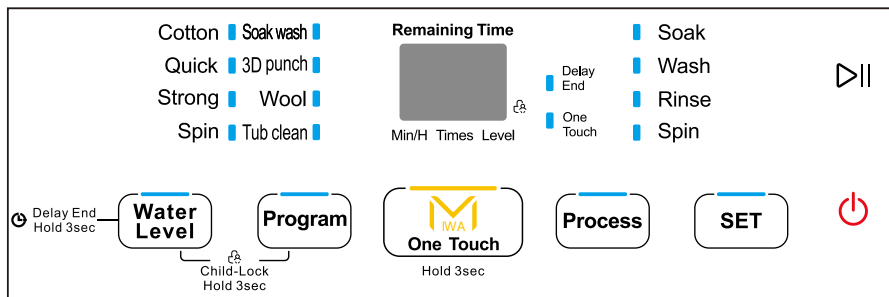

Note: Control panel picture is for reference only, actual product may have slight difference

1. POWER ON/OFF 
Press once to turn the washing machine On/Off.

2. START/PAUSE 
Press to start or pause the washing program

3. PROCESS INDICATOR

The four process “Soak”, “Wash”, “Rinse”, “Spin”; will be displayed accordingly. Press PROCESS button to determine which process is needed. The combination of these process can be adjusted to your needs.



4. ONE TOUCH / IWA (Intelligent Wash Assistant)

Automatic wash program that can detect the wash capacity and adjust the water level accordingly to achieve optimum performance. 3 ways to use:

- When the washing machine is off: Press and hold the ONE TOUCH button for 3 seconds, the light will turn on at the same time; or
- Press POWER button first, then press and hold the ONE TOUCH button for 3 seconds. The washing program will start and the ONE TOUCH light will blink; or
- Press POWER button first, press ONE TOUCH button, then press the START/PAUSE button. The washing program will start and the ONE TOUCH light will blink.



5. DELAY END

Useful delay program if you want to schedule a wash at a certain time. This delay program can be set up to 24 hours. Press and hold the WATER LEVEL button for 3 seconds to enter the delay program setting mode. Press the WATER LEVEL button again to set the delay.



6. PROGRAM

To select the desired washing program. The washing machine is equipped with 8 washing programs. Press the button and the program indicator light will show the selected programme. Press the START/PAUSE button to start the program.

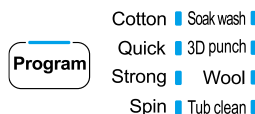

7. WATER LEVEL

To determine the water level manually for each selected wash programme. Press the button to select the water level cycled as follows:

→ 1 → 2 → 3 → 4 → 5 → 6 → 7 → 8 →



8. CHILD LOCK

To lock the control panel so that it cannot be played by children either intentionally or accidentally. Press and hold the WATER LEVEL & PROGRAM button for 3 seconds until the CHILD LOCK indicator dot lights up. Use the same method to unlock CHILD LOCK. The CHILD LOCK function can only be activated when the washing machine is on.

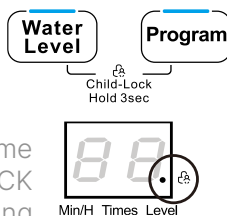

9. DIGITAL DISPLAY

The digital display of the washing machine has several functions, including:

- Shows remaining washing time or water level **18**
- Shows the delay time for the delayed program **4H.**
- Shows an error code if a malfunction occurs **E1**

PART 5: MAINTENANCE

Cleaning & Maintenance

1. Periodic cleaning & maintenance can prolong the life time of your appliance
2. Ensure the power cord is unplugged before performing cleaning and maintenance activity
3. Please wipe the body with a soft and clean cloth every time after the washing machine is used. When there are serious stains, please wipe the body with a cloth dipped in appropriate detergents or soapy water.
4. Do not spray water on the body directly
5. Do not wipe the body with chemicals such as putty-powder, diluting agents, gasoline and alcohol
6. Clean the Door Seal. Please wipe stains and foreign matters such as thread chips away with a towel every time after using. If there are foreign matters such as pins in the groove of the door seal, please take them out.

Cleaning the Lint Filter

After every wash, it is recommended to always wash the lint filter in order to maintain the washing machine's cleanliness.

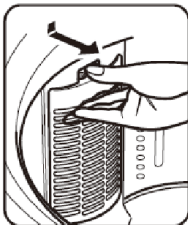

Press and pull the filter

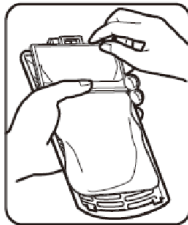

Take out the filter net

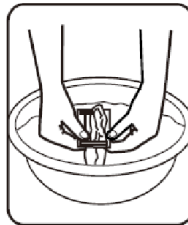

Wash and clean the net from dirt and lints

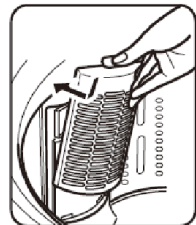

Reinstall the filter until you hear click sound

Tub Clean

It is recommended to perform tub washing so that the washing tub is always kept clean. Use the TUB CLEAN program to wash the tub at least once a month.

Cleaning the Inlet Valve

1. Remove the water inlet hose from the washing machine
2. Remove the filter from the inlet valve
3. Clean the filter with a toothbrush or suitable tool
4. Reattach to intake valve
5. Connect the water inlet hose
6. It is recommended to do this every 6 months.



Inlet water valve

PART 6: TROUBLESHOOTING

Before contacting service center, check the following table:

Problem	Possible Cause	Recommended Action
Appliance is not working	<ul style="list-style-type: none">• Power plug is plugged incorrectly• Switch is in OFF condition	<ul style="list-style-type: none">• Ensure the appliance is properly plugged into the power socket and the switch is turned ON.
Poor Spinning and abnormal noise	<ul style="list-style-type: none">• Transportation bolt still attached• Incorrect installation• Overloading/overfilling the drum• Incorrect adjustment of feet	<ul style="list-style-type: none">• Remove the transportation bolt• Install on a hard and level surface• Load the drum according to the recommended capacity• Adjust and lock the adjustable feet
Too much bubble	<ul style="list-style-type: none">• Improper use of detergent	<ul style="list-style-type: none">• Use low foam detergent for washing machine

Problem	Possible Cause	Recommended Action
Door cannot be opened	<ul style="list-style-type: none"> • Program is running 	<ul style="list-style-type: none"> • Wait until the program is finished
E1 – Spin failure	<ul style="list-style-type: none"> • The laundry is unbalanced in the washer • Uneven surface 	<ul style="list-style-type: none"> • Rearrange the laundry so that it is balanced • Place it on a flat surface
E2 – Water supply failure	<ul style="list-style-type: none"> • Closed faucet • Clogged hose/filter • Water pressure too low 	<ul style="list-style-type: none"> • Make sure the faucet is open • Check and clean the hose/filter • Check your home's water pressure
E3 – Drain failure	<ul style="list-style-type: none"> • Drain hose too high • Drain hose clogged 	<ul style="list-style-type: none"> • Install the Drain hose as recommended • Clean drain hose
E4 – Washing machine won't work	<ul style="list-style-type: none"> • When the machine is washing or spinning, if the door is opened the drum stops rotating and error E4 appears 	<ul style="list-style-type: none"> • Close the washing machine door again and the washing machine will continue the washing program
EL – Washing machine won't work or drain	<ul style="list-style-type: none"> • Child lock is active or door is open 	<ul style="list-style-type: none"> • Close the door or turn off child lock
EA / EC – Other problem	<ul style="list-style-type: none"> • Other problem 	<ul style="list-style-type: none"> • Turn off the washing machine and unplug the power • Call the Service Center immediately for repairs

PART 7: SPECIFICATION

Model	WT 1120 UF**
Type	Top Load
Wash Capacity (kg)	11.0
Max. spin speed (rpm)	680
No. of programs	8
Inlet pressure (MPa)	0.03-0.80
Power Input (Watt)	525
Voltage & Frequency	220-240V~50Hz
Product dimension (WxDxH)(mm)	550×582×940
Product weight (kg)	37

**WH = White; GY = Grey; SR = Silver

Design and specification can change without prior notice to improve the quality of the product. The illustration in this manual is schematic and can be different with your actual product. The values on label or in other documents are according to laboratory test and relevant standards. Values can vary depending on the actual operational and environmental condition of the product.

Ciao! **MODENA**

www.modena.com

PT MODENA INDONESIA

Jl. Industri Raya I Blok D-8,
Jatiuwung, Tangerang 15135