

User Manual Book Built In Oven

BO 7838

BO 6633

BO 6435

BO 3435

BO 4630

BO 2733

BO 2638

BO 2633

BO 1733

BO 4660

BO 2763

BO 2668

BO 2663

TABLE OF CONTENTS

Part 1: Safety Warnings	3
Part 2: Name of Parts	4
Part 3: Installation	6
Part 4: How to Use	10
Control Panel and Timer BO 4630 dan BO 4660	10
Control Panel and Timer BO 1733, BO 2633, BO 2663, BO 2733, BO 2763, BO 3630	12
Control Panel and Timer BO 6633	16
Electronic Timer Setting on BO 4660	17
Electronic Timer Setting on BO 4630	18
Operating Oven Control Unit BO 7838	20
Control Panel BO 3435 dan BO 6435	24
Oven Function Settings BO 3435 dan BO 6435	25
Oven Function Settings BO 7838	28
Oven Function Settings BO 2663 dan BO 2763	67
Part 5: Maintenance	70
Maintenance and Cleaning BO 7838	73
Part 6: Problem & Solution	77
Part 7: Precaution Action	79
Part 8: Specification	81
Appendix 1	85
Appendix 2	86

This guide book explains everything you need to know about your new product. Please contact our Customer Care should you need further assistance through www.modena.com

PART 1: SAFETY WARNINGS

- Please independently use sockets with rated current above 25A. Reliable grounding must be guaranteed. Please do not use loose or poor contact power sockets, or it easily leads to electric shock, short circuit and fire; if the equipment share one socket with other electric appliances, fire may be caused for abnormal heating.
- When unplugging socket, hold the plug end with a hand to pull it out; do not unplug with the hand holding power cord, otherwise electric shock, short circuit, fire and other dangers will be caused.
- Only professional repair technicians can disassemble, repair and transform the equipment.
- If the equipment is idle for a long time, please unplug the power plug or turn off the power supply of the product.
- During use the appliance becomes hot. Care should be taken to avoid touching heating elements inside the oven.
- **WARNING:** Accessible parts may become hot during use. Young children should be kept away.
- Do not use harsh abrasive cleaners or sharp metal scrapers to clean the oven door glass, since they can scratch the surface, which may result in shattering of the glass.
- This appliance is not intended for use by persons (including children) with reduced physical, sensory or mental capabilities, or lack of experience and knowledge, unless they have been given supervision or instruction concerning use of the appliance by a person responsible for their safety. Children should be supervised to ensure that they do not play with the appliance.
- **WARNING:** The appliance and its accessible parts become hot during use. Care should be taken to avoid touching heating elements. Children less than 8 years of age shall be kept away unless continuously supervised.
- If the supply cord is damaged, it must be replaced by the manufacturer, its service agent or similarly qualified persons in order to avoid a hazard

PART 2: NAME OF PARTS

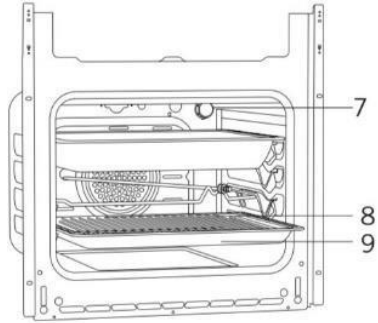
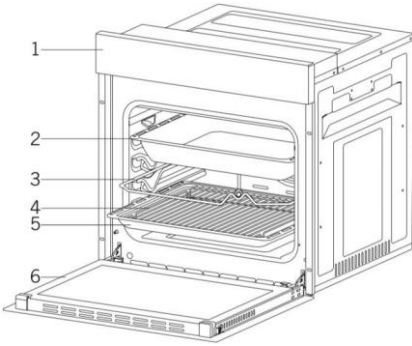

Part names:

1) Control panel

2) Deep Tray

3) Chicken Roast Skewer

4) Wire Grill Inside Tray

5) Standard Tray

- Image is a general overview and is not necessarily the same as the product you receive
- The features and product specification depend on the product type.







6) Oven Door

7) Light

8) Grilling Wire

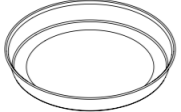
9) Standard Tray

Accessories (optional)

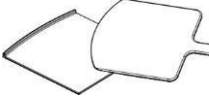
<p>Deep Tray Used for pastry, big roasts, watery foods. It can also be used as oil collecting container if you roast directly on grill with cake, frozen foods and meat dishes..</p>	
<p>Tray / Glass tray * Used for pastry (cookie, biscuit etc.), frozen foods.</p>	
<p>Circular tray * Used for pastry frozen foods.</p>	
<p>Wire grill Used for roasting or placing foods to be baked, roasted and frozen into desired rack.</p>	
<p>Telescopic rail * Trays and wire racks can be removed and installed easily thanks to telescopic rails.</p>	
<p>In tray wire grill * Foods to stick while cooking such as steak are placed on in tray grill</p>	
<p>Pizza stone and peel * They are used for baking pastries such as pizza, bread, pancake and removing baked food from the oven.</p>	

Tray handle *
It is used to hold hot trays.

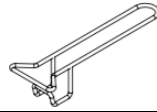

PART 3: INSTALLATION

Cooling fan shall take extra steam out and prevent outer surfaces of appliance from overheating during operation of the oven. This is a necessary condition for better appliance operation and better cooking. Cooling fan shall continue operation after cooking is finished. Fan shall automatically stop after cooling is completed.

A space shall be left behind the compartment where you shall place your appliance to ensure efficient and proper operation of your appliance. This space shall not be neglected as it is necessary for the operation of the ventilation system of the appliance.

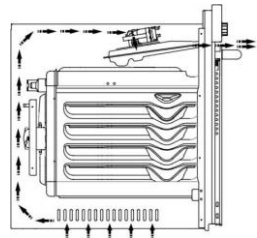

Installation and Assembly Of The Oven

Operating space of the appliance shall be determined before starting the installation. Appliance shall not be installed on areas with high flow of air.

Handle the appliance with two persons at least. Do not drag the appliance to prevent damage to the ground. Remove all transportation materials inside and outside of the packaging. Remove all materials and documents inside the product.

Installation in a Bottom Cabinet

Cabinet shall conform with dimensions specified in picture 2

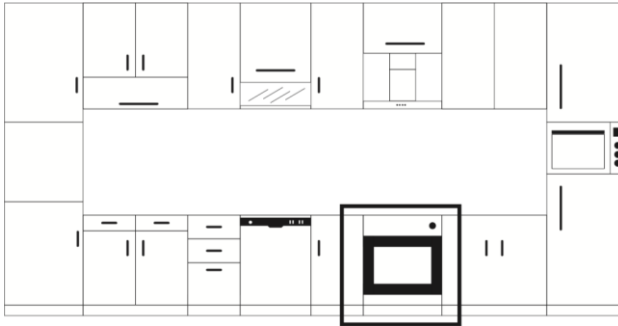

Picture 2

Installation in a high Cabinet

The cabinet shall comply with the dimensions given in picture 3. In the rear part of the cabin, and at the top and bottom, spaces with the dimensions specified in the picture shall be ensured to provide the required ventilation.



Picture 3

The dimensions of the appliance are given in picture 4.

The furniture surfaces to be installed and the installation materials to be used shall resist a temperature of at least 100 °C.

To prevent the appliance from turning over, the cabinet to be installed shall be fixed and the cabinet floor shall be level.

The floor of the cabinet shall be strong enough to withstand a load of at least 60 kg.

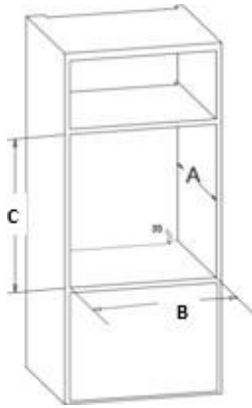

Picture 4

MODEL	A (mm)	B (mm)	C (mm)
BO 1733	550	560	580
BO 2633	550	560	580
BO 2638	550	560	580
BO 2663	550	560	580
BO 2668	550	560	580
BO 2733	550	560	580
BO 2763	570	560	585
BO 3435	550	560	448
BO 6435	550	560	448
BO 4630	550	560	580
BO 4660	570	560	580
BO 6633	550	560	580
BO 7838	550	560	585

Placing and Securing the Oven

Place the oven to the cabinet with two or more persons. Make sure that the frame of the oven and the front of the furniture are properly aligned. The supply cord shall not be left under the oven or be stuck or bent between the oven and the furniture. Secure the oven to the furniture using the screws supplied in the appliance. Screws shall be installed by putting them through the plastics attached on the frame of the appliance as shown in picture 5. The screws shall not be tightened too much. Otherwise, the screw holes may wear out.

Check that the oven does not move after installation. If the oven has not been installed in accordance with the installation instructions, there is a risk of overturning during operation.

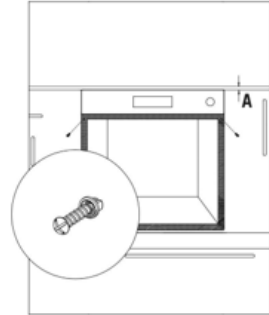

Picture 5

Electrical Connection

The place where the product shall be installed shall have proper electrical installation. The mains voltage shall comply with the rating given on the product type plate.

Connection of appliance shall be made in accordance with local and national electrical regulations.

Disconnect the mains power before starting to install the product. Do not connect the product to the mains until the installation is finished.

At the front of the kitchen counter, a space at least 5 mm high from the bottom of the counter should be left

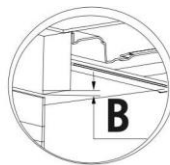
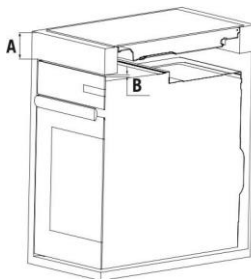







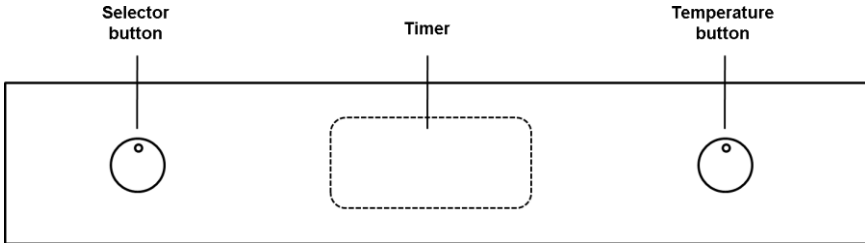

A	Min. 80 mm
B (Air outlet)	5 mm

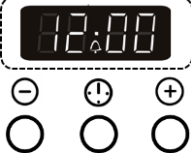
PART 4: HOW TO USE

Control Panel and Timer BO 4630 and BO 4660

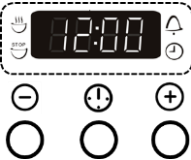







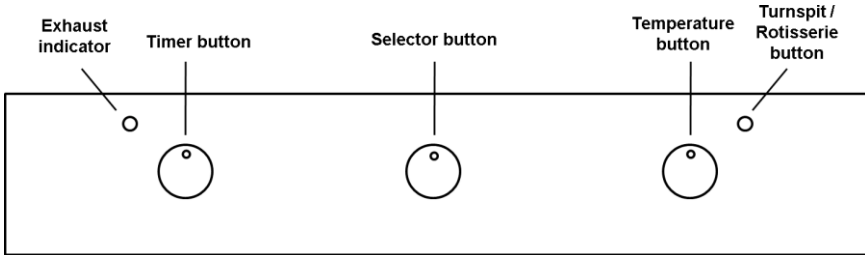



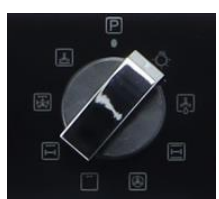

MODEL	Control Panel
BO 4630	
BO 4660	

<p>BO 4660</p> 		<p>Selection button To select a function.</p>
		<p>Plus button</p>
		<p>Minus button</p>
<p>BO 4630</p>		<p>Countdown indicator (Alarm) To set a countdown (alarm), a signal sound after the time has ended. This function does not affect the operation of the oven.</p>
		<p>Time indicator To set, change and check the time.</p>
		<p>Cook Time indicator To set how long the oven is to be in use.</p>
		<p>End Time indicator To set when the oven is to switch off again.</p>

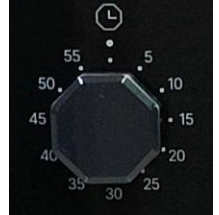
Control Panel and Timer BO 1733, BO 2633, BO 2638, BO 2663, BO 2668, BO 2733, BO 2763, BO 3630



MODEL	Selector Program	Thermostat	Timer
BO 1733			
BO 2633			
BO 2663			

BO 2733			
BO 2763			
BO 2638			
BO 2668			









NOTE:





All function will start after selecting the temperature with the thermostat knob

The oven is equipped with:

- A lower heating element
- An upper heating element, which according to the cooking mode can be used for grilling or baking.

- A circular heating element, which surround the fans

	<p>Oven Lamp When you turn the control knob to position  the light will be on</p>
	<p>Defrosting with fan The air at ambient temperature is distributed inside the oven for defrosting food more quickly and without proteins adulteration</p>
	<p>Turnspit Turn around the knob to the position like picture beside, the turnspit will work.</p>
	<p>Natural convection Both the lower and upper heating elements operate together. The heating process from 2 aim from the top and bottom. This function also able to work with turn spit (roisserie). Ideal to cook simultaneously for some foods.</p>
	<p>Fan Oven To use a fan oven, turn the knob program first to fan symbol, and then turn the burner knob to the bottom stove, fan oven will work after a fire oven on the bottom of the furnace is on. The fan will not work when the stove top oven is at work. Hot air is distributed evenly in the oven by the fan. This function is suitable for cooking some foods (meat, fish) at the same time without affecting the taste and smell. Also used for cooking pastries.</p>
	<p>Back element + oven fan (Convection oven) Both the fan and the circular heating elements operate together. The hot air distributed inside the oven. This is ideal for cooking several pastries types.</p>
	<p>Medium grill Hot temperature is emitted from the top with a half of element heater. This feature is allows you to grilling in smaller quantities economically.</p>

	<p>Total grill</p> <p>Hot temperature is emitted from the top with a full element heater. This feature is used to grilling large amount or large size. This function also can use turn spit (roisserie).</p>
	<p>Fan assisted total grill</p> <p>The heated air by the grill heating element is circulated by the fan and helps to distribute the heat between 50°C and 200°C. The fan assisted grill replaces the turnspit perfectly.</p>
	<p>Lower heating element + fan</p> <p>The heated air by lower heating element is circulated by the fan and helps to distribute the heat between 50°C and 200°C.</p>
<p>★</p> 	<p>Grill/upper Burner with Automatic Ignition</p> <p>To use the grill burner, turn the knob to position like the picture beside. Upper burners already has automatic ignition and make sure the oven door is closed.</p>
<p>★</p> 	<p>Bottom Burner With Automatic Ignition</p> <p>To use the bottom burner, turn the knob to position the picture. Bottom burner already has automatic ignition and make sure the oven door is closed.</p>

Timer BO 2633, BO 2638, BO 2663, BO 2668, BO 2733, BO 3630

- Timer is equipped with a buzzer that can be adjusted up to a maximum of 60 minutes.
- Turn the timer knob clockwise to position 60 minutes then turn back anticlockwise to the desire position
- After The time-out or the knob position back to ● (blac point), it will sound a warning sound / alarm

Timer BO 1733, BO 2763

- To use the timer, set the buzzer by turning the knob clockwise. The numbers correspond to minutes (maximum 120 minutes).

- The end of cooking buzzer does not turn off the oven.

Control Panel and Timer BO 6633



Operation Button

On / Off Switch	Program	Light	Timer	Setting switch for Temperature, Clock and Timer		Rapid Heat-up	OK

Functions & Operation

In the condition of power connection, or short circuit, PCB will be reset, all functions will return to default.

1. Press button to start oven, the press to select function, then press to confirm.
2. When you switch function, the set End working time and Duration time will be invalid.
3. If working temperature was reset, oven will stop working, and also alarm. Must press to restart alarm.
4. New temperature and function setting must be confirmed by pressing OK.
5. Under function mode, keep pressing to enter standby mode. And display will show current time.

The sequence of cooking modes displayed in the screen as below:

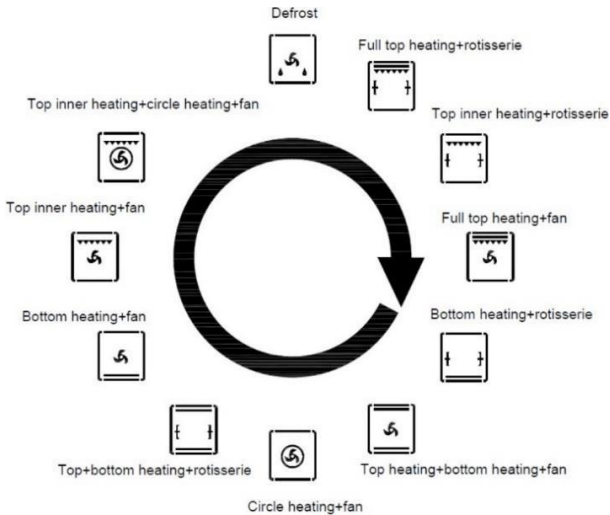

Electronic timer setting on BO 4660

At BO 4660, Timer serves as a reminder (alarm), it does not affect the oven work.

When the oven has been connected to the electrical supply, the display flashes 0:00. Press Plus button to enter the alarm setting mode. Press Minus button to enter the alarm setting. Press “function setting” to enter the time setting mode.

Time setting

Press Selection button to enter the time setting mode. Press “+” or “-” to set the time, confirmation will be done automatically after 3 seconds.

Alarm setting

Alarm function can be adjusted 0:10~99 (minute:second). Press Plus button to enter the alarm setting mode and the symbol  will be displayed in the screen.

Press Plus or Minus to set the time, confirmation will be done automatically after 3 seconds. When the time is over, 0:00 and  be shown in the display, and the sound “Di, Di, Di ...” happens. After 7 mins, the sound stops and the display shows the current time. User can also press Plus to stop the alarm sound.

Change or delete the alarm setting

Press Plus to enter the alarm setting again. The symbol  flashes in the screen. Press Plus or Minus to amend the alarm time. When the setting is adjusted to 0:00, the alarm is cancel.

Alarm sound setting.

Press Minus button to enter the setting of alarm sound. Press Selection button to enter the time setting mode. There are 3 types of alarm sounds can be set.

Electronic timer setting on BO 4630

At BO 4630, Timer can be to set the cooking time.

Before use for the first time, set and change the hours according to the daily time The oven only operates when the time has been set

When the appliances has been connected to the electrical supply or where there has been a power cut, the power

indicator Time flashes automatically.

1. To change the time that has already been set, press the selection button repeatedly, until the function indicator Time flashes.
2. Set the current time using Plus or Minus button.

After approx. 5 seconds, the flashing stops and the clock displays the time of day set. The oven is now already to use.

The time can only be changed if neither of automatic functions (Cook Time or End Time) have been set.

Countdown (Alarm)

1. Press Selection button repeatedly, until the function indicator Countdown flashes.
2. Using the Plus or Minus button, set the required Countdown (max. 2 hours 30 minutes).

After approx. 5 seconds, the display shows the remaining time. The function indicator Countdown will light up.

When the time has ended, the function indicator flashes and buzzer will ring for 2 minutes. Press any button to switch off the signal.

Cook Time

1. Press Selection button repeatedly, until the function indicator Cook Time flashes.
2. Using the Plus or Minus button, set the required cooking time.

After approx. 5 seconds, the display returns the current time. The function indicator Countdown will light up.

When the time has ended, the function indicator flash, an acoustic signal will sound for 2 minutes and the oven will switch it self off.

Press any button to switch off the signal and the program.

End Time

1. Press Selection button repeatedly, until the function indicator Cook Time flashes.

2. Using the Plus or Minus button, set the required switch off time

After approx. 5 seconds, the display returns the current time. The function indicator Countdown will light up.

When the time has ended, the function indicator flash, an acoustic signal will sound for 2 minutes and the oven will switch it self off.

Press any button to switch off the signal and the program.

Cook time and End time combine

Cook time and End time can be used simultaneously, if the oven is to be automatically switched on and off at a later time.

1. Using the function Cook time set the period of time that the dish requires to cook. Example, the cooking time is 1 hour.

2. Using the function End time, set the time at which the dish is to be ready. Example, the dish is to be ready at 14:05.

3. The function indicators Cook time and End time light up and the time is shown in the display. Example, the current time is 12:05.

4. The oven will automatically switch itself on at the appropriate time as calculated. Example, oven automatically switch itself on at 13:05 and will switch itself off when the cooking time set has elapsed.

Example, at 14:05 (according to the time that has been set previously, see no. 2)



Indicator light

1. The indicator will be light up until the selected temperature when turning the thermostat knob, and will switch off when the selected temperature is reached.

2. The indicator for cooling fan will light up when the cooling fan is switch on.



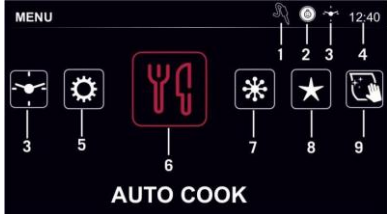





3. And indicator lights grill / turnspit will light up if the player grill / turnspit enabled

Operating Oven Control Unit BO 7838

	<ol style="list-style-type: none"> 1. Meat probe 2. Child lock 3. Minute minder 4. Hour 5. Settings 	<ol style="list-style-type: none"> 6. Auto cooking 7. Special functions 8. Favourites 9. Cleaning
	<ol style="list-style-type: none"> 1. Return Button <ul style="list-style-type: none"> • Short press: Returns back when navigating the menus. • Long press: When cooking, cancels the cooking cycle. 2. Rotary Knob <ul style="list-style-type: none"> • Right / Left turning: Navigates between selections • Short press: Enables the selection • Long press: Pauses cooking, cleaning and other functions 3. MENU Button <ul style="list-style-type: none"> • Enters to the menu • Enables reminder and child lock during cooking cycle 4. ON / OFF Button <ul style="list-style-type: none"> • Short press: Turns on / off the oven • Long press: Cancels the cooking cycle and turns off the oven during cooking. 	





Symbols on the Display

Appliance features a “TFT” display

	Eco (Economic) cooking		Low temp cooking
	<i>Meat Probe</i>		Shabbat
	Defrost		Yoghurt
	Dough		Warm Keeping



Temperature

Temperature symbols of the oven are defined in the following table.

	Quick heating (pre-heating)		Meat Probe
	Heat bars (oven cavity temperature display)		Temperature Display (°C)





Time Management

The oven time symbol is determined in the following table

	Normal Cooking		Delayed Cooking
	Minute Minder		

Cook

The oven cooking symbol is defined in the following table

	Lower Resistance		Upper Resistance
	Grill Resistance		Turbo Resistance
	Turbo Fan		







Setting

The oven setting symbol is defined in the following table

	Key Tone		Child Lock
---	----------	---	------------



Automatic Cooking Menu

The automatic cooking menu symbol is defined in the following table.

	Meat		Pizza
	Poultry		Bread
	Fish		Oven Food
	Cake		Spesial

End of Cooking Function

End of Cooking Function menu symbol is defined in the following table.











	Save Favorite		Extend Duration
	Finish Cooking		

When the Oven Is Turned On for the First Time

Oven is deactivated when it is turned on for the first time. Clock that is not updated displays on the screen.

Simply follow several steps below to perform the clock setting;

- Press ON/OFF button to turn on the oven. Then press MENU button to enter the menu.
- Select time of day entering settings sub-menu
- Make hour and minute adjustment using rotary knob

	<p>Lower and upper resistances Recommended temperature is 200 °C Allows cooking from 45 °C to 240 °C Up to 6 hours of cooking is possible .</p>		<p>Grill, Turbo and fan Recommended temperature is 220 °C . Allows cooking from 120 °C to 230 °C . Up to 6 hours of cooking is possible</p>
	<p>Lower resistance , upper resistance and fan Recommended temperature is 180 °C . Allows cooking from 45 °C to 240 °C . Up to 6 hours of cooking is possible .</p>		<p>Upper resistances Recommended temperature is 150 °C . Allows cooking from 120 °C to 230 °C . Up to 2 hours of cooking is possible .</p>
	<p>Turbo and fan Recommended temperature is 175 °C . Allows cooking from 45 °C to 240 °C . Up to 8 hours of cooking is possible .</p>		<p>Lower resistances Recommended temperature is 200 °C . Allows cooking from 60 °C to 230 °C . Up to 8 hours of cooking is possible</p>
	<p>Lower - upper resistances , turbo and fan Recommended temperature is 180 °C . Allows cooking from 60 °C to 240 °C . Up to 5 hours of cooking is possible .</p>		<p>Lower resistances, Turbo, and Fan Recommended temperature is 150 °C . Allows cooking from 45 °C to 230 °C . Up to 4 hours of cooking is possible</p>
	<p>Grill Recommended temperature is 180 °C . Allows cooking from 120 °C to 230 °C . Up to 1 hours of cooking is possible</p>		<p>Upper resistances , Turbo, and Fan Recommended temperature is 150 °C . Allows cooking from 45 °C to 230 °C . Up to 4 hours of cooking is possible</p>
	<p>Grill & Upper resistance Recommended temperature</p>		<p>Grill, Upper Resistance ,and Turnspit Recommended</p>

	is 200° C . Allows cooking from 120° C to 230° C . Up to 1 hours of cooking is possible .		temperature is 200° C . Allows cooking from 120° C to 230° C . Up to 1 hours of cooking is possible
	Grill & Fan Recommended temperature is 175° C . Allows cooking from 120° C to 230° C . Up to 1 hours of cooking is possible		Grill, Fan ,and Turnspit Recommended temperature is 175° C . Allows cooking from 120° C to 230° C . Up to 1 hours of cooking is possible
	Grill, fan, & upper resistance Recommended temperature is 185° C . Allows cooking from 120° C to 230° C . Up to 1 hours of cooking is possible .		Grill, Turbo, Fan ,and Turnspit Recommended temperature is 185° C . Allows cooking from 120° C to 230° C . Up to 1 hours of cooking is possible

Control Panel BO 3435 and BO 6435

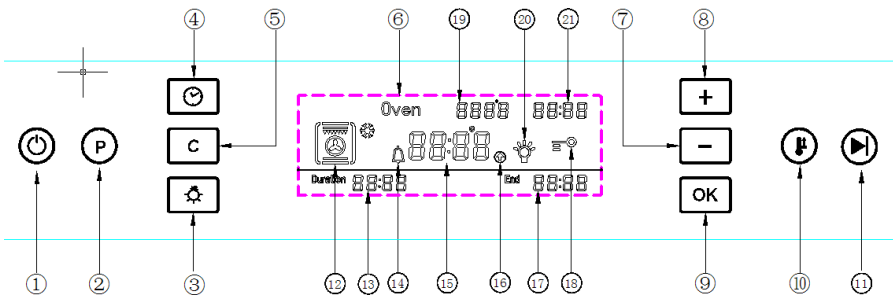

1	On/Off Switch	8	Plus button	15	Time & Temperature
2	Program button	9	OK button	16	Heat up symbol
3	Light button	10	Heat up button	17	End cooking time
4	Timer button	11	Start/Stop button	18	Child lock symbol

5	Temperature button	12	Cooking Mode Symbol	19	Temperature setting
6	Display screen	13	Cooking time	20	Light symbol
7	Minus Button	14	Alarm symbol	21	Time of day

Oven function settings BO 3435 and BO 6435

- Time of day / Alarm Clock / Cooking time / End of time setting



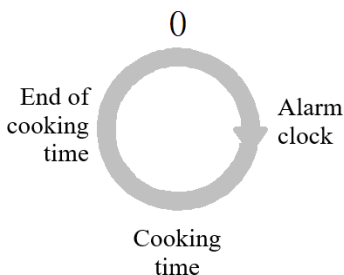

The sequence of cooking modes displayed in the screen as below:





1. Time of Day: Press key for 2 seconds, press / to adjust the time, press to confirm
2. Alarm Clock : Press “ ” key once, press / to set the cooking time, press to confirm. The display will show the symbol
3. Cooking time “Duration”: Press “ ” key twice, press / to set the cooking time 00 : 00 (hour : min), press to confirm.

For example: The time is 12:00 now, user sets the cooking time to 0:30 (hour:min), then press to set the end of time to 12:40. The oven starts to cook at 12:10, and the display shows the end time of cooking.



Function setting

1. Press the “ P ” key to switch on the oven. User can between the cooking modes by continuously pressing the “ P ” key.
2. Set the temperature by pressing “ C ” key then press  /  to set the temperature . Press  to confirm after the cooking mode is selected. Once the cooking mode is fixed, press the key “  ” to start cooking, press repeatedly to switch between the start and pause.

Rapid heat – up







When the setting temperature exceeds 100 degrees and the pre-heat function hasn't been finished, user can press the key  to start the rapid heat-up mode. The display shows the symbol  continuously.

Child Lock Set

Press “  ” key for 2 seconds. The display will show the child lock symbol “  ” .To disable the child lock, hold  again for 2 seconds until the symbol disappears.

Cooking mode symbols:

The sequence of cooking modes displayed in the screen as below:

Function	Working Parts	Default Temperature	Adjustable Temperature Range.
	Fan motor	50°C	20 – 60°C
	Lower heating element	220°C	50-250°C
	Lower heating element + Fan motor	220°C	50-250°C
	Total grill element + Turnspit	220°C	50-250°C
	Circle heating element + Fan motor	220°C	50-250°C
	Total grill element + Lower heating element + Turnspit	220°C	50-250°C
	Total grill element + Lower heating element + Fan motor + Turnspit	220°C	50-250°C

Oven Function Settings BO 7838

Manual Cooking

Normal Cooking



The steps you need to follow to start cooking are explained below.

	<ol style="list-style-type: none">1. The oven is turned on by pressing the on/off button. Then, when the rotary knob is pressed once, the cooking menu opens.2. Rotate the rotary knob to navigate between functions. Press the rotary knob to select a function.
---	--

ATTENTION!

While navigating between functions, the temperature values displayed on the temperature display are the recommended temperature values. Temperature may be changed between maximum and minimum temperatures specified at 5°C intervals

	<ol style="list-style-type: none">3. Rotate the rotating knob to select temperature and press the rotating knob to select the time.
---	---

	<p>4. Rotate the rotating knob to select the time</p>
	<p>5. Before cooking cycle starts, summary information screen is displayed. Press the rotary knob to start cooking or press return button to change the settings.</p>
	<p>6. Once cooking starts, the screen on the side is displayed</p>

ATTENTION!

- Simply press the rotary knob for 1 seconds to pause cooking
- Simply press and hold return button for 2 seconds to cancel cooking completely



ATTENTION!

To change cooking settings; press return button after pausing the cooking cycle and return back to cooking time, temperature setting and cooking function adjustment. Cooking cycle can be restarted with desired settings.







ATTENTION!

Reminder can be set or child lock can be activated pressing MENU button during cooking.







7. Once cooking ends, 3 options will be given to the user. Rotate the rotating knob right or left to select one from "end cooking", "finish cooking" and "add favourite" options. When end cooking is selected, cooking cycle ends and when continue cooking is selected cooking cycle can be extended.

Delayed Cooking

 <p>MANUAL COOKING 12:40</p> <p> 200° 00:10 </p>	<p>After selecting cooking function, temperature and time from summary information screen, press MENU button.</p>
 <p>MANUAL COOKING 12:40</p> <p>Do you want delayed cooking?</p> <p>Yes</p> <p>No</p>	<p>After pressing MENU button, delayed cooking option will be asked to the user. If Yes is selected, end of cycle time is requested.</p>
 <p>MANUAL COOKING 12:40</p> <p>Please enter end of cooking time</p> <p>18:40</p> <p>18:50</p> <p>18:55</p>	<p>After selecting end of cycle, press the rotary knob to start cooking cycle.</p>
 <p>Cooking in Progress... 12:40</p> <p>MANUAL MODE</p> <p>⌚ 00:10</p> <p>🌡️ 200 °C</p> <p>12:40 12:45 12:50</p>	<p>The screen of the side shows an example of 5 minutes delayed cooking. Blue section in progress bar represents delayed time, and red section represents cooking time.</p>

Cooking with pre - heating

 <p>MANUAL COOKING 12:40</p> <p>□ 200° 00:10 </p>	<p>After selecting cooking function, temperature and time from summary information screen, press MENU button.</p>
 <p>MANUAL COOKING 12:40</p> <p>Do you want delayed cooking?</p> <p>Yes No</p>	<p>Delayed cooking option will be asked to the user on this screen. Select "No".</p>
 <p>MANUAL COOKING 12:40</p> <p>Do you want preheating?</p> <p>Yes No</p>	<p>After selecting "No", pre-heating option will be asked to the user. If "Yes" is selected, cooking cycle will start with pre-heating.</p>
 <p>Cooking in Progress... 12:40</p> <p>MANUAL MODE</p> <p>⌚ 00:10 🔥 200 °C</p> <p>12:40 ————— 12:50</p>	<p>The screen of the side shows an example of 5 minutes delayed cooking. Blue section in progress bar represents delayed time, and red section represents cooking time.</p>

ATTENTION!

If delayed cooking is selected, pre-heating cannot be selected



Auto Cooking



Auto cooking menu presents 54 recipes prepared by expert chefs to the user. By auto cooking menu, user simply selects desired recipe and starts cooking. Cooking function, temperature, cooking time and rack position will be selected and applied by Simfer Intelligent Oven depending on the type and weight of the food.

ATTENTION!

When using auto cooking, make sure pre-heating ends before placing the food inside the oven.

To Start auto cooking cycle

	<p>Press ON/OFF button to turn on the oven. Then press MENU button and rotate the rotary knob to select cooking sub-menu. Press the rotary knob to enter auto cooking menu.</p>
	<p>After entering auto cooking menu, select of from meat, poultry, fish, muffin, pizza, bread, oven dishes or special dish categories depending on desired dish.</p>
	<p>After selecting food category, select desired recipe.</p>

	<p>After selecting recipe, cooking settings screen is displayed. In cooking settings screen, rotate the rotary knob to select the weight in grams and press the rotating knob to confirm the selection.</p>
	<p>Afterwards select cooking intensity and press the rotating knob to confirm the selection.</p>
	<p>After selecting cooking intensity, summary information screen is displayed.</p>

ATTENTION!

It is required to enter weight and cooking intensity (low, normal, high) for meat, poultry and fish category. For other recipes this is not valid.

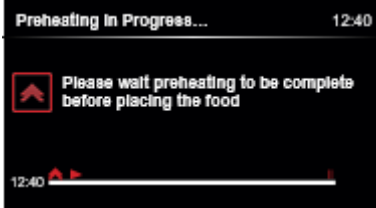
	<p>Press the rotary knob once to start cooking cycle. Once cooking cycle starts pre-heating activates, wait for pre-heating ends before placing the food inside the oven</p>
---	--

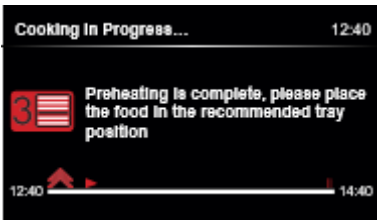







Once pre-heating is completed, a warning signal is emitted and recommended rack number is displayed on the screen. At this stage, place the food on recommended rack. Press the rotary knob to clear the warning.





After pre-heating completed warning is cleared, cooking screen is displayed. Yellow section in pro- gress bar represents pre-heating, and red section represents cooking time.

ATTENTION!



- Simply press and hold rotary knob for 1 second to stop cooking.
- Simply press and hold return button for 2 seconds to cancel cooking completely.
- Once auto cooking is completed, the user can finish cooking or extend cooking time.





	<p>Meat Probe</p> <p>Meat Probe provides the food to be cooked at desired temperature</p>		<p>Defrost</p> <p>Used for defrosting</p> <p>The Maximum operating time is specified as 8 hours</p>
	<p>Eco Cooking Function</p> <p>You may save energy using this mode The recommended temperature is 170 °</p> <p>C. The temperature may be set from 45 ° C to 240 ° C</p> <p>The Maximum operating time is specified as 6 hours</p>		<p>Yoghurt</p> <p>Used for curing Yoghurt</p> <p>Recomended operating period is 5 hours</p>
	<p>Slow Cooking Function</p> <p>Enables slow cooking</p> <p>The recommended temperature is 100 °</p> <p>C. The temperature may be set from 45 °</p> <p>C to 150 ° C. The Maximum operating time is specified as 6 hours</p>		<p>Dough</p> <p>Used for dough</p> <p>Recomended operating period is 5 hours</p>

	<p>Shabbat</p> <p>The recommended temperature is 100 ° C. The temperature may be set from 45 ° C to 150 ° C</p> <p>The Maximum operating time is specified as 24 hours</p>		<p>Shabbat</p> <p>The recommended temperature is 70 ° C. The temperature may be set from 45 ° C to 100 ° C</p> <p>The Maximum operating time is specified as 6 hours</p>
---	--	---	--

To use special functions; turn on the oven using ON/OFF button and press MENU button. Select special functions sub-menu in this menu and select desired special function.

Meat Probe Function

	<p>To use meat probe; insert the meat probe to its socket inside the oven in main menu, meat probe is displayed on the screen. Then press the rotary knob to cooking settings menu.</p>
	<p>There are 3 functions to be selected with meat probe (grill, fan, turbo fan and grill). Select one from them and press the rotary knob.</p>

	<p>At this stage, select target temperature of meat probe. When meat probe temperature changes, cavity temperature will also be changed accordingly. When temperature selecting is completed, press the rotating knob to enter cavity temperature setting</p>
	<p>If changing the cavity temperature is desired different temperatures can be adjusted.</p>
	<p>After temperature setting is done, press the rotating knob to display summary information screen.</p>
	<p>Press the rotary knob again to start cooking cycle.</p>

ATTENTION!

Recommended temperature for cooking with meat probe is 75°C Minimum setting temperature is 55°C and maximum setting temperature is 98°C.

- Long press the rotary knob to pause the cooking cycle.



Reminder can be set or child lock can be activated pressing MENU button during cooking.







When cooking ends, the cycle can be finished or extended. To extend the cooking cycle, select a higher meat probe temperature.

Economic Cooking Function



Press ON/OFF button to turn on the oven. Press MENU button and rotate the rotary knob to select special functions menu. Press the rotary knob to enter special functions menu.

	<p>After entering special functions menu, press the rotary knob to select economic cooking function and press the rotating knob to make temperature and time settings</p>
	<p>Rotate the rotating knob to select temperature and press the rotating knob to select the time.</p>
	<p>Rotate the rotating knob to select the time</p>
	<p>Before cooking cycle starts, summary information screen is displayed. Press the rotary knob to start cooking.</p>



Once cooking starts, the screen on the side is displayed.



WARNING: Reminder can be set or child lock can be activated pressing MENU button during cooking.

Slow Cooking Function



Press ON/OFF button to turn on the oven. Press MENU button and rotate the rotary knob to select special functions menu. Press the rotary knob to enter special functions menu



After entering special functions menu, press the rotary knob to select low temp cooking function and press the rotating knob to make temperature and time settings.

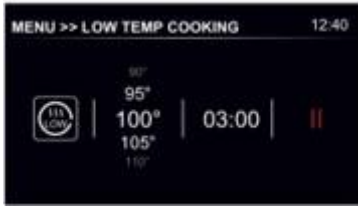

Rotate the rotating knob to select temperature and press the rotating knob to select the time.



Rotate the rotating knob to select the time.

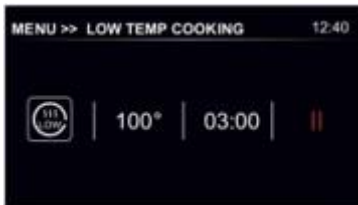





Before cooking cycle starts, summary information screen is displayed. Press the rotary knob to start cooking.



Once cooking starts, the screen on the side is displayed

Shabbat Function

	<p>Press ON/OFF button to turn on the oven. Press MENU button and rotate the rotary knob to select special functions menu. Press the rotary knob to enter special functions menu.</p>
	<p>After entering special functions menu, press the rotary knob to select Shabbat cooking function and press the rotating knob to make temperature and time settings</p>
	<p>Rotate the rotating knob to select the temperature.</p>
	<p>Before the function starts, summary information screen is displayed. Press the rotary knob to start the function.</p>



After Shabat function is started, the screen on the side is displayed

Defrosting Function



Press ON/OFF button to turn on the oven. Press MENU button and rotate the rotary knob to select special functions menu. Press the rotary knob to enter special functions menu



After entering special functions menu, press the rotary knob to select defrost function and press the rotating knob to make the time settings.



Rotate the rotating knob to select the time.







Before defrost function starts, summary information screen is displayed. Press the rotary knob to start defrost function.





After defrost function is started, the screen on the side is displayed.

Yoghurt Function

	<p>Press ON/OFF button to turn on the oven. Press MENU button and rotate the rotary knob to select special functions menu. Press the rotary knob to enter special functions menu.</p>
	<p>After entering special functions menu, press the rotary knob to select yoghurt function and press the rotating knob to make the time settings.</p>
	<p>Rotate the rotating knob to select the time.</p>
	<p>Before yoghurt function starts, summary information screen is displayed. Press the rotary knob to start yoghurt function.</p>



	<p>After yoghurt function is started, the screen on the side is displayed</p>
---	---





Dough Function

	<p>Press ON/OFF button to turn on the oven. Press MENU button and rotate the rotary knob to select special functions menu. Press the rotary knob to enter special functions menu.</p>
	<p>After entering special functions menu, press the rotary knob to select dough function and press the rotating knob to make the time settings.</p>
	<p>Rotate the rotating knob to select the time.</p>

	<p>Before dough function starts, summary information screen is displayed. Press the rotary knob to start dough function</p>
	<p>After dough function is started, the screen on the side is displayed</p>

Keeping Warm Function

	<p>Press ON/OFF button to turn on the oven. Press MENU button and rotate the rotary knob to select special functions menu. Press the rotary knob to enter special functions menu.</p>
	<p>After entering special functions menu, press the rotary knob to select keeping warm function and press the rotating knob to make temperature and time settings.</p>



	<p>Rotate the rotating knob to select temperature and press the rotating knob to select the time.</p>
	<p>Rotate the rotating knob to select the time</p>
	<p>Before keeping warm function starts, summary information screen is displayed. Press the rotary knob to start keeping warm function.</p>
	<p>After keeping warm function is started, the screen on the side is displayed</p>

Favourite Mode Setting

Cooking settings may be saved when you want to use these setting again. Your oven features a memory for 32 favourite settings.

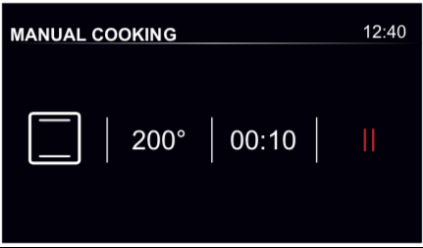

You may add your dishes into favourites in two ways



1. Adding to favourite during cooking

	<p>After setting cooking function, cooking temperature, and desired cooking time, stop cooking by pressing and holding the rotary knob for 1 second while the dish is being cooked in the oven.</p>
	<p>Press MENU button once and favourite add menu is displayed on the screen.</p>
	<p>Rotate the rotary knob to navigate between characters, and press the rotary knob to select desired character. If desired, press the rotary knob to delete selected character. The users can give a special favourite name for their dishes with this procedure.</p>

 <p>MENU > SAVE FAVOURITE 12:40</p> <p>BTK</p> <p>Favorite cook is saved successfully</p>	<p>After selecting favourite name, press MENU button to save it. A confirmation message such as favourite saved will be displayed.</p>
---	--

2. Adding to favourite after cooking



 <p>END OF COOKING 12:40</p> <p>ADD FAVOURITE</p>	<p>After manual cooking is completed; add favourite menu will be presented to the user. Press the rotating knob to select add favourite option.</p>
 <p>MENU > SAVE FAVOURITE 12:40</p> <p>Z [X] _ A B C D</p>	<p>Add favourite menu will be displayed on the screen.</p>
 <p>MENU > SAVE FAVOURITE 12:40</p> <p><u>B</u> <u>T</u> <u>K</u> _ _ _ _ _</p> <p>I I J K L M N</p>	<p>Rotate the rotary knob to navigate between characters, and press the rotary knob to select desired character. If desired, press the rotary knob to delete selected character. The users can give a special favourite name for their dishes</p>

	with this procedure.
 <p>MENU > SAVE FAVOURITE 12:40</p> <p>BTK</p> <p>Favorite cook is saved successfully</p>	After selecting favourite name, press MENU button to save it. A confirmation message such as “favourite saved” will be displayed
 <p>MENU > SAVE FAVOURITE 12:40</p> <p>BTK</p> <p>The favorite named “XXX” is already exist, do you want to replace favorite?</p> <p>Yes</p> <p>No</p>	If the name given to the favourite is already in use, the screen shown of the side will be displayed. If you save, this favourite will be replacing the old one.

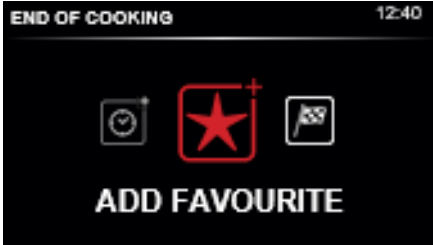

ATTENTION!

- Settings remain in the memory even if the power is interrupted.
- Favourite settings may not be used for cooking with meat probe and auto cooking.

Delete Favourite

	<p>Press ON/OFF button to turn on the oven. After pressing MENU button, rotate the rotary knob to select favourites menu. Press the rotary knob to enter favourites menu.</p>
	<p>Rotate the rotating knob to select the favourite to be deleted and press MENU button.</p>
	<p>If your reply is “Yes” for the question on the screen by pressing the rotary knob, selected favourite will be deleted.</p>

Using Saved Favourite



	<p>Press ON/OFF button to turn on the oven. After pressing MENU button, rotate the rotary knob to select favourites menu. Press the rotary knob to enter favourites menu.</p>
	<p>Rotate the rotating knob to select the favourite to be used and press the rotary button.</p>
	<p>Then summary information screen for the saved favourite will be displayed. Press the rotary knob to start favourite cooking or press RETURN button to change the settings</p>



Cleaning

This allows cleaning of the dirt that is softened by the steam occurred inside the oven. A few steps that shall be realized before starting the steam cleaning are explained below:

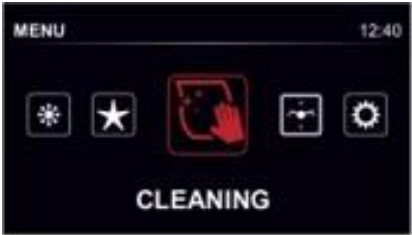
1. Remove all accessories from the oven.
2. Put half a litre of water in the tray, and place the tray to the bottom of the cooker.
3. Operate the steam cleaning function.
4. After operating the oven for 30 minutes, open the door and wipe the inner surfaces of oven with a damp cloth.
5. Clean the oven using dish washing detergent, warm water, and a soft cloth for dirt that does not come out easily and wipe the area you have cleaned with a dry cloth.

To Set The Steam Cleaning Function

	<p>Press ON/OFF button to turn on the oven. After pressing MENU button, rotate the rotary knob to select cleaning menu. Press the rotary knob to enter cleaning menu.</p>
	<p>Select steam cleaning function.</p>



	<p>Before steam cleaning function starts, summary information screen is displayed. Press the rotary knob to start steam cleaning function.</p>
	<p>Once steam cleaning starts, the screen on the side is displayed.</p>

Minute Minder





Minute Minder is an alarm that can be set both for the cooking cycle or independently. Minute Minder can be used in two ways:

1. Setting minute minder during cooking cycle

	<p>During cooking cycle press MENU button, rotate the rotary knob to select the minute minder and press the rotary knob to enter minute minder setting screen.</p>
--	--

	<p>Rotate the rotating knob to select Minute Minder time and press the rotating knob to confirm the selection</p>
	<p>If a time other than preset times is desired, rotate the rotary knob to “adjust time” option.</p>
	<p>Press the rotary knob to enter “adjust time” option and rotate the rotary knob to select the time. Press the rotary knob again to confirm time selection.</p>
	<p>Reminder icon will be displayed on the screen. After Minute Minder time expires, a warning signal will be emitted</p>

2. Setting minute minder independent from cooking cycle

	<p>Press ON/OFF button to turn on the oven. After pressing MENU button, rotate the rotary knob to select minute minder menu. Press the rotary knob to enter Minute Minder menu.</p>
	<p>Rotate the rotating knob to select minute minder time and press the rotating knob to confirm the selection.</p>
	<p>If a time other than pre-set times is desired, rotate the rotary knob to “adjust time” option.</p>
	<p>Press the rotary knob to enter “adjust time” option and rotate the rotary knob to select the time. Press the rotary knob again to confirm time selection.</p>



WARNING: Warning signal will be emitted for 7 minutes, if no button is pressed.

WARNING: Reminder icon () will disappear from the screen when warning signal turns off.

ATTENTION!



- Warning signal will be emitted for 7 minutes, if no button is pressed.
- Reminder icon will disappear from the screen when warning signal turns off.

Settings





Press ON/OFF button to turn on the oven. After pressing MENU button, rotate the rotary knob to select setting menu. Press the rotary knob to enter settings menu.

1. Time of Day

 <p>MENU > SETTINGS 12:40</p> <p>CONTRAST CHILD LOCK TIME OF DAY DATE LANGUAGE</p>	<p>After entering settings menu, rotate the rotary knob to select time of day. Press the rotary knob to enter hour of day setting.</p>
 <p>MENU >> TIME OF DAY 12:40</p> <p>10 11 12:40 13 14</p>	<p>Rotate the rotary knob to make hour and minute adjustment. Press the rotary knob to confirm the setting.</p>

2. Date

 <p>MENU > SETTINGS 12:40</p> <p>CHILD LOCK TIME OF DAY DATE LANGUAGE KEY TONE</p>	<p>After entering settings menu, rotate the rotary knob to select the date. Press the rotary knob to enter date setting.</p>
--	--

	<p>Rotate the rotary knob to make date, month and year adjustment. Press the rotary knob to confirm the setting.</p>
---	--



3. Language



	<p>After entering settings menu, rotate the rotary knob to select language setting. Press the rotary knob to enter language setting.</p>
	<p>Rotate the rotary knob to adjust language. Press the rotary knob to confirm the setting.</p>

4. Key Tone

 <p>MENU > SETTINGS 12:40</p> <p>DATE LANGUAGE KEY TONE BRIGHTNESS CONTRAST</p>	<p>After entering settings menu, rotate the rotary knob to select key tone setting. Press the rotary knob to enter key tone setting</p>
--	---

Rotate the rotary knob to adjust key tone from 3 different options. When volume is changed, key tone changes also. Additionally, key tone can be muted. Press the rotary knob to confirm the setting.

 <p>MENU >> KEY TONE 12:40</p>	<p>When key tone is adjusted to mute, the screen on the side will be displayed</p>
 <p>MENU >> KEY TONE 12:40</p>	<p>When key tone is adjusted to 1st level, the screen on the side will be displayed.</p>

 <p>MENU >> KEY TONE 12:40</p>	<p>When key tone is adjusted to 2nd level, the screen on the side will be displayed.</p>
 <p>MENU >> KEY TONE 12:40</p>	<p>When key tone is adjusted to 3rd level, the screen on the side will be displayed.</p>

ATTENTION!

At the end of cooking cycle or when reminder is set, appliance emits a warning signal even it is in mute mode.

5. Brightness

 <p>MENU > SETTINGS 12:40</p> <p>LANGUAGE KEY TONE BRIGHTNESS CONTRAST CHILD LOCK</p>	<p>After entering settings menu, rotate the rotary knob to select brightness setting. Press the rotary knob to enter brightness setting.</p>
--	--

	<p>Rotate the rotary knob to adjust brightness level. Press the rotary knob to confirm the setting.</p>
---	---

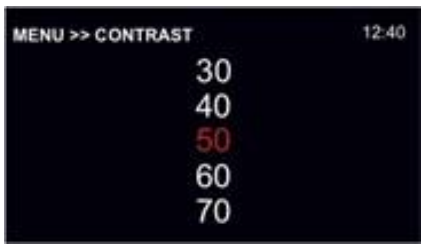

6. Contrast

	<p>After entering settings menu, rotate the rotary knob to select contrast setting. Press the rotary knob to enter contrast setting.</p>
	<p>Rotate the rotary knob to adjust contrast level. Press the rotary knob to confirm the setting.</p>





7. Child Lock

Child lock can be activated in 2 different ways

1. Activate the lock switch during the cooking cycle

 <p>MENU 12:40</p> <p>CHILD LOCK</p>	<p>During cooking cycle press MENU button and rotate the rotary knob to select child lock.</p>
 <p>MENU >> CHILD LOCK 12:40</p>	<p>Press the rotary knob to enter child lock setting.</p>
 <p>MENU >> CHILD LOCK 12:40</p> <p>To deactivate childlock, press MENU button for 2 sec</p>	<p>Press the rotary knob to activate child lock.</p>

2. Activating child lock independent from cooking cycle

 <p>MENU 12:40</p> <p>SETTINGS</p>	<p>Press ON/OFF button to turn on the oven. After pressing MENU button, rotate the rotary knob to select setting menu. Press the rotary knob to enter settings menu.</p>
 <p>MENU > SETTINGS 12:40</p> <p>BRIGHTNESS CONTRAST CHILD LOCK TIME OF DAY DATE</p>	<p>After entering settings menu, rotate the rotary knob to select child lock.</p>
 <p>MENU >> CHILD LOCK 12:40</p>	<p>Press the rotary knob to enter child lock setting.</p>
 <p>MENU >> CHILD LOCK 12:40</p> <p>To cancel the child lock Long press MENU button.</p>	<p>Press the rotary knob to activate child lock.</p>

Oven Function Settings BO 2663, BO 2668 & BO 2763

Using bottom burner :

	<ol style="list-style-type: none"> 1. Turn and push the knob for lighting the lower oven burner counterclockwise until desired temperature 2. After the burner is turn on, let during more or less 10 minutes in order to the hot temperature in oven become to spread evenly. 3. Open the door oven, and then insert the cooking material above the chrome shelf 4. To set the heating level, turn the knob to the number position level of desired temperature.
	<ol style="list-style-type: none"> 5. Cooking process can be monitoring from oven door glass when the oven light is on. To turn on the oven light, turn around the knob to the light oven symbol.
	<ol style="list-style-type: none"> 6. To turn off the bottom oven burner, turn the knob clockwise until this symbol of OFF flame

Using upper burner (Grill) :

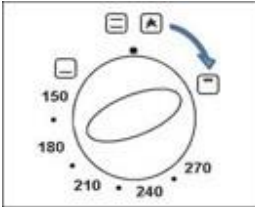

1. Push and turn around the knob to the symbol of light burner
2. Put the tray into the bottom shelves with distances around 0.5 cm to prevent oil drop from the food
3. Install the chrome shelves on the top shelf
4. Insert the food that will be cooked on the chrome shelves
5. After a few minutes, turn over the food. (To know how long to grill and time to turn over the food, please see the attached table on the back of the instruction manual).

Turn on the bottom oven burner (oven gas) – without automatic ignition
 Open the oven door

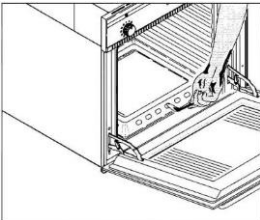

A. The Bottom oven burner

Light the matches, then approach the flame to the hole in the middle of base oven, on the same timer, push and turn the knob for the bottom oven to counter clockwise until to the desired temperature.

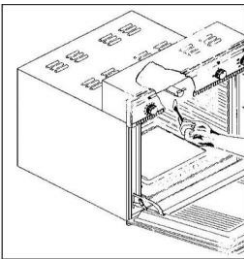

B. The upper oven burner (Grill)

Light the matches, then approach the flame to the hole in the middle of base oven, on the same timer, push and turn the knob for the upper oven to counter clockwise until to the desired temperature.

Make sure the upper or bottom oven burner is on (flame is already) before released the knob thermostat. If the flame does not turn on, please repeat the procedure (point A & B) until flame already to use, before closed the oven door

Using Grill Turnspit

The turnspit (grill) can be use when the upper or bottom oven burner are turned on.

- Turn on the upper or bottom oven burner. To turn on, follow the instruction: Using the bottom or upper oven burner. Then wait for a few second in order to spread the heat.
- Food/Meat that will be cooked, place into the turnspit and install between both forks.

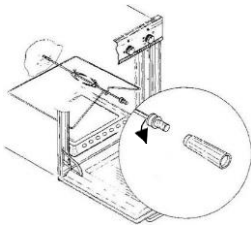
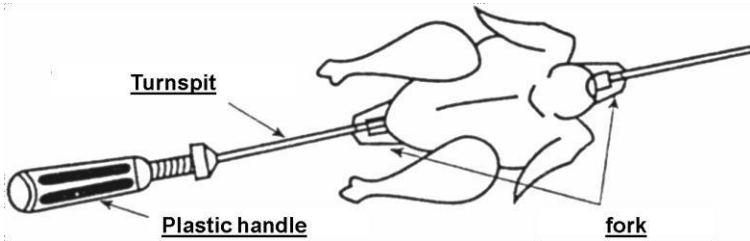

Insert turnspit with the food into the oven by inserting the turnspit to the special hole / socket that located on rear of oven.

ATTENTION!

After the turnspit is in the right position, remove plastic handle from the turnspit

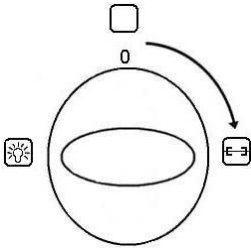

1. Close the oven door slowly
2. Turn on the spit motor grill by turning the knob to the turnspit symbol
3. After the meat is ready, turn off the turnspit, and then reset the plastic handle to the turnspit before discharging the turnspit from special hole / socket.

- Image is a general overview and is not necessarily the same as the product you receive
- The features and product specification depend on the product type.

PART 5: MAINTENANCE

ATTENTION!

- Wait for the appliance to cool down before attempting to clean it.
- Disconnect it from the power supply
- Do not leave corrosive or acidic substances (lemon juice, vinegar, etc.) on enameled, painted or stainless steel parts.

Cleaning the Oven

- After using the oven, let the oven door open for several minutes to cool it down.
- Ideally, the inside part of the oven is cleaned after each use.
- Clean the oven when it's still warm to make it easier to remove spilled food.
- Clean the rubber, stainless, chromed, or enameled parts with soft sponge and warm soap water that does not contain abrasive ingredients. Use cleaning chemicals for stubborn stains. After cleaning the oven, let it air dry

completely.

- All accessories—except sliding shelves—can be washed like regular cooking equipment or put inside the dishwasher.
- Do not use steam or high-pressured cleaners.

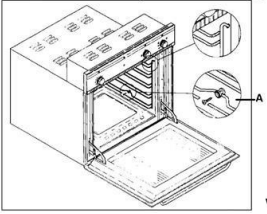

Cleaning the Oven Light

- Disconnect the oven from the power supply, either by pulling the plug out or by switching off the power supply at the mains
- Remove the protection glass (A) and replacement the broken out bulb with the same type of bulb
- Installed the cover protection “A”

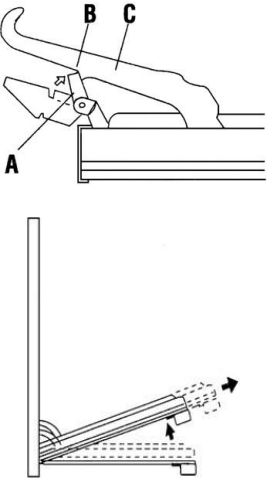

Removing the Oven Door

To make the cleaning process easier, the oven door can be detached by following these steps :

- Move hook A towards hinge B until it's locked to the C part.
- Open the door halfway, then pull the door using both hands to detach the door
- To reattach the door, do the same steps in reverse order

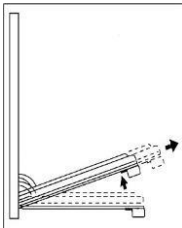
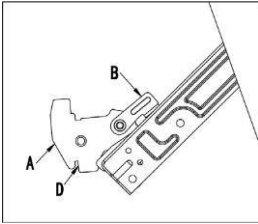

Removing the Oven Door

To water down in cleaning oven, door oven earn released by :

- Open the door completely and lift the 2 levers “B”
- Now, shutting the door slightly, you can lift it out by pulling out the hooks “A” as shown the right picture.

To reassemble the door

- With the door in vertical position, insert tow hooks “A” into the slots.
- Ensure the seat “D” is hooked perfectly on to the edge of the slots (move the oven door backward and forward slightly)
- Keep the oven door open fully, unhook the 2 levers “B” downward and then shut the door again.

Clean the glass with a sponge and cleaning products are non-abrasive, then dry with a soft cloth. Do not use materials that are abrasive or have sharp surfaces as it can scratch the surface and cause the glass to crack.

Inspect the seal.

Check the seal around the doors on a regular basis. If the seal is damaged, contact the MODENA Call Center for a repair or replacement. It is advised not to use the oven if the seal have not been replaced or repaired.

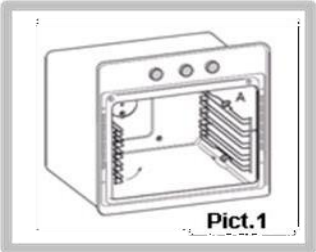
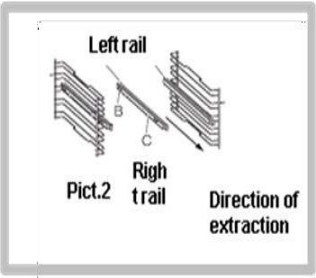
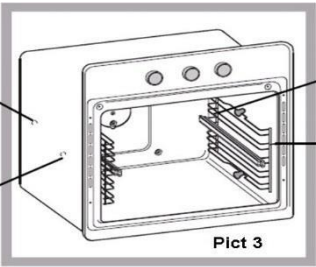
 <p style="text-align: right;">Pict.1</p>	<p>Installation sliding rack / “ sliding rack kit “ (for selected models).</p> <p>To Install sliding racks :</p> <ul style="list-style-type: none"> Remove the two frame, which the lifting of the spacer A (see Pic.1)
 <p style="text-align: center;">Pict.2</p>	<ul style="list-style-type: none"> Choose where you want to install the rack sliding shelves, Pay attention to the direction of the sliding shelf which should be extracted (see the orientation B and C in order). (See Pict.2)
 <p style="text-align: center;">Pict 3</p>	<ul style="list-style-type: none"> Tighten the second frame with guide rails using holes are provided in the wall of the oven. Holes for order lies in the holes left F1, F2 and order on the D1, D2. (see Pict.3). Finally, spacer off order on A.

Maintenance and Cleaning BO 7838

Periodical cleaning extends the appliance’s life and reduces frequent problems.

- Unplug the appliance to avoid shock hazard.
- Wait until the appliance cools down before cleaning it. Hot surfaces may cause burns.
- Do not clean the interior parts, panel, trays and other parts of the appliance

with sharp tools such as bristle brushes, steel wool or knives. Do not use abrasive and scratching materials or detergents.

- After cleaning the internal parts of the appliance with a soapy cloth, rinse and dry them thoroughly with a soft cloth.
- Clean glass surfaces with special glass cleaning materials.
- Do not clean your appliance using steam cleaners.
- Do not use flammable materials such as acids, thinner or gas to clean your appliance.
- Do not wash any component of your appliance in a dishwasher.
- Use potassium stearate (soft soap) for dirt and stains.
- Clean the control panel with a wet cloth and then dry it with a dry cloth.
- Product must be thoroughly cleaned after each use. This way, it will be possible to remove the food remains easily and to prevent these remains from burning when the appliance is used again.
- Make sure to wipe the remaining liquids away completely after cleaning and immediately clean the dishes that are splashed around during cooking.
- Some detergents or cleaning agents may damage the surface. Do not use abrasive detergents, cleaning powders, cleaning creams or sharp objects during cleaning.

Cleaning of the Oven Glass

Open the oven door. Pull out the plastic latches on the right and left side as shown in picture 9 and pull out the profile towards yourself as shown in picture 10. Glass is free after the profile is removed as shown in picture 11. Carefully pull the glass that has been detached towards you. The outer glass is fixed to the oven door profile. You may easily clean the glasses after they have been separated. Once the cleaning and maintenance is complete, you may reinstall the glass by performing the removal procedure in reverse. Make sure that the profile is seated properly.

Catalytic Panel *

It is located behind the wire racks of the oven, at the right and left walls of oven cavity. Catalytic panel removes offensive odor and provides using your appliance at its best performance. Over time, oil and food odors permeate into enameled

oven walls and heating elements. Catalytic panel absorbs any food and oil odors, and burns them during cooking to clean your oven.

Replacement of The Oven Lamp

- Disconnect power supply and wait for the oven to cool down to eliminate the risk of electrocution before replacing the oven lamp. Hot surfaces may cause burns.
- Remove the glass protector by rotating it. Using plastic gloves may help you if you have difficulty in rotating it.
- Then, remove the lamp by rotating it, and install the new lamp with the same specifications. Replace the glass protector, plug the appliance and complete the replacement procedure. You may now use your oven.

Cleaning and assembly of the oven door



Figure 7

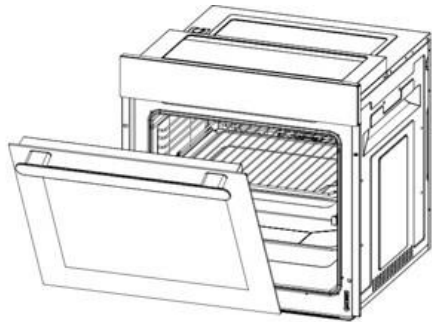

Figure 8

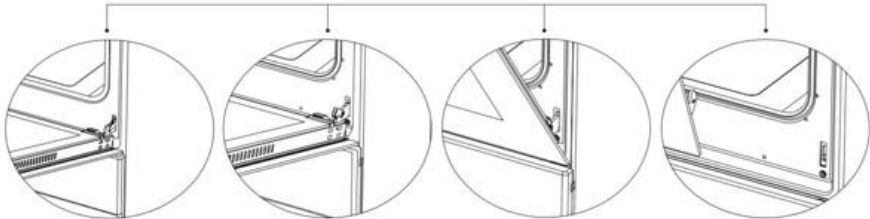

Figure 7.1	Figure 7.2	Figure 8.1	Figure 8.2
<p>Open the door completely by pulling the oven door toward you. Then, as shown in Figure 7.1, pull the hinge lock up with a screwdriver and perform the unlocking operation.</p>	<p>As shown in Figure 7.2, bring the hinge lock to the maximum angle. Bring both hinges that connect the oven door to the oven to the same position.</p>	<p>Then, close the oven door you have opened so that it shall lean against the hinge lock as shown in figure 8.1.</p>	<p>To remove the oven door, hold the door with both hands when it is at a close level to the closed position, and pull it up as shown in Figure 8.2.</p>

PART 6: PROBLEM & SOLUTION

PROBLEM	POSSIBLE CAUSE	RECOMMENDED ACTION
Oven does not operate.	Power supply not available.	Check for power supply.
Oven stops during cooking	Plug comes out from the wall socket.	Re-install the plug into wall socket.
Turns off during cooking	Too long continuous operation.	Let the oven cool down after long cooking cycles
	Cooling fan not operating	Listen the sound from the cooling fan.
	Oven not installed in a location with good ventilation.	Make sure spaces specified in operating instructions are maintained.
	More than one plugs in a wall socket.	Use only one plug for each wall socket.
Outer surface of the oven gets very hot during operation.	Oven not installed in a location with good ventilation.	Make sure spaces specified in operating instructions are maintained.
Oven door is not opening properly.	Food residues jammed between the door and internal cavity	Clean the oven well and try to re-open door
Oven light is dim or does not operate	Foreign object covering the lamp during cooking	Clean internal surface of the oven and check again
	Lamp might be failed.	Replace with a lamp with same specifications
Electric shock when touching the oven	No proper grounding	Make sure power supply is grounded properly
	Ungrounded wall socket is used	

Water dripping		
Steam coming out from a crack on oven door	Water or steam may generate under certain conditions depending on the food being cooked.	Cool down and then wipe dry with a cloth.
Water remaining inside the oven.	This is not a fault of the appliance.	
The cooling fan continues to operate after cooking is finished.	The fan operates for a certain period for ventilation of internal cavity of the oven.	This is not a fault of the appliance; therefore you don't have to worry.
Oven does not heat.	Oven door is open.	Close the door and restart.
	Oven controls not correctly adjusted.	Read the section regarding operation of the oven and reset the oven.
	Fuse tripped or circuit breaker turned off.	Replace the fuse or reset the circuit breaker. If this is repeating frequently, call an electrician.
Smoke coming out during operation.	When operating the oven for the first time	Smoke comes out from the heaters. This is not a fault. After 2-3 cycles, there will be no more smoke.
	Food on heater.	Let the oven to cool down and clean food residues from the ground of the oven and surface of upper heater.
When operating the oven burnt or plastic odor coming out.	Plastic or other not heat resistant accessories are being used inside the oven.	At high temperatures, use suitable glassware accessories.

Oven does not cook well.	Oven door is opened frequently during cooking.	Do not open oven door frequently, if the food you are cooking does not require turning. If you open the door frequently internal temperature drops and therefore cooking result will be influenced.
--------------------------	--	---

PART 7: PRECAUTION ACTION

Advice and precautions

This unit is designed and manufactured in compliance with international safety standards. Warnings and instructions below is for safety reasons and must be read and followed carefully.

General Safety Instructions

- The unit is designed for household and indoors use and is not intended for commercial use or industry.
- Unit should not be installed in an open area. It is very dangerous to let the unit exposed to rain.
- When moving and installing the unit, always use the attached handrail on the oven.
- Do not touching the side of the unit with wet and bare feet or wet hands.
- Unit should be used only by adults to prepare the dish according to the instructions in the guide book.
- Do not touch the heating element or a particular part of the oven door when the unit is used, since some parts become very hot. Keep children away from the oven and do not touch the hot parts of the electrical wiring directly.
- Make sure other electronic appliances are not in contact with the hot parts of the oven.
- The room for ventilation and heat dissipation should not be obstructed.
- Always grasp the middle part of the oven handle, the end part of the handle

could be hot.

- Always wear gloves when placing or removing the cutlery into or out of the oven.
- Do not use aluminum foil to line the oven bottom.
- Do not put flammable materials in the oven, if the unit is accidentally turned on, these material can burn.
- Always make sure the knob on the “●”/“○” position when the unit is not in use.
- When you disconnect the power cord, always pull from the cable head, do not pull the cord.
- Always unplug the power cord from its source when doing maintenance or repairing to the unit. If there is damage on the unit, however, do not try to fix it by yourself. Repairs that carried out by inexperienced person could potentially cause injury or further damage to the unit. Contact MODENA authorized Call Center for repair.
- Do not put or lean heavy objects on the oven door.
- Do not let the children play with the unit.
- Units are not to be used by people (including children) with a limited physical abilities, sensory, or mental; or lack of experience and knowledge about these products, unless they have been given supervision or instruction concerning the use of tools by a person responsible for their safety.
- Always turn off the oven before removing the oven rack and plates.
- During the cooking process, fats or oils should be treated cautiously because this material is likely to cause a fire when reaching a certain temperature.
- When you smell gas, immediately release the regulator from the gas tank, do not light a fire and immediately contact MODENA Call Center.
- Frequently check the gas hose, to make sure that gas hose is far from hot surface, and not in bent position. Make sure the outer surface of hose isn't cracked so that can be a leakage.
- Always remember that certain parts of the gas stove may feel hot for a long time (around 30 minutes) after you turn off the gas stove.
- Perform a routine service on your built-in oven every 3 (three) months, so any abnormalities on your built-in oven can be detected and repaired immediately.

PART 8: SPECIFICATION

MODEL	BO 7838	BO 6633	BO 4630
Oven type	Electric Oven	Electric Oven	Electric Oven
Cooking program	16	11	8
Color	Diamond Black	Diamond Black	Diamond Black
Oven capacity (liter)	80 L	67	67
Convection fan	Yes	Yes	Yes
Turn spit	Yes	Yes	Yes
Door glass	3 Layer	3 Layers	3 Layers
Oven Light	Yes	Yes	Yes
Thermostat	Yes	Yes	Yes
Timer	Yes (Digital)	Yes (digital)	Yes
Oven tray	Yes	Yes	Yes
Dripping pan	Yes	Yes	Yes
Voltage	220 – 240 V / 50Hz	220 – 240 V/Hz	220 – 240 V/Hz
Lower heater	1200 W	1200 W	1200 W
Back heater	1800 W	2100 W	2100 W
Upper/grill Heater	1200 & 2400 W	1000 & 1900 W	1000 & 1900 W
Product dimension (L x W x H) mm	595 x 610 x 595	595 x 610 x 595	595 x 610 x 595
Cut-out dimension (L x W x H) mm	560 x 550 x 580	560 x 550 x 580	560 x 550 x 580

MODEL	BO 3435	BO 6435
Oven type	Electric Oven	Electric Oven
Cooking program	7	7
Color	Stainless Steel	Diamond Black
Oven capacity (liter)	40	40
Convection fan	Yes	Yes
Turn spit	Yes	Yes
Door glass	3 Layer	3 Layer
Oven Light	Yes	Yes
Thermostat	Yes	Yes
Timer	Yes	Yes
Oven tray	Yes	Yes
Dripping pan	Yes	Yes
Voltage	220 – 240 V / 50 Hz	220 – 240 V / 50 Hz
Lower heater	1000 W	1000 W
Back heater	1460 W	1460 W
Upper/grill Heater	1090 W	1090 W
Product dimension (L x W x H) mm	595 x 610x 455	595 x 610x 455
Cut-out dimension (L x W x H) mm	560 x 550 x 448	560 x 550 x 448

MODEL	BO 2733	BO 2633	BO 2638	BO 1733
Oven type	Electric Oven	Electric Oven	Electric Oven	Electric Oven
Cooking program	8	8	8	6
Color	Diamond Black	Diamond Black	Diamond Black	Diamond Black
Oven capacity (liter)	70	56	56	70
Convection fan	Yes	Yes	Yes	Yes
Turn spit	Yes	Yes	Yes	No
Door glass	3 Layers	3 Layers	3 Layers	3 Layers
Oven Light	Yes	Yes	Yes	Yes
Thermostat	Yes	Yes	Yes	Yes
Timer	Yes	Yes	Yes	Yes
Oven tray	Yes	Yes	Yes	Yes
Dripping pan	Yes	Yes	Yes	Yes
Voltage (Volt)	220 - 240	220 - 240	220 - 240	220 - 240
Lower heater	1200 W	1200 W	1200 W	1100 W
Upper Heater	1000 & 1900 W	1000 & 1900 W	1000 & 1900 W	900 & 1350 W
Product dimension (L x W x H) mm	595 x 610 x 595	595 x 610 x 595	595 x 610 x 595	595 x 610 x 595
Cut-out dimension (L x W x H) mm	560 x 550 x 580	560 x 550 x 580	560 x 550 x 580	560 x 550 x 580

MODEL	BO 4660	BO 2763	BO 2663	BO 2668
Oven type	Gas Oven	Gas Oven	Gas Oven	Gas Oven
Cooking program	6	5	5	5
Color	Diamond Black	Diamond Black	Diamond Black	Diamond Black
Oven capacity (liter)	67	73	56	56
Convection fan	Yes	-	-	-
Turn spit	Yes	Yes	Yes	Yes
Door glass	3 Layers	3 Layers	3 Layer	3 Layer
One Hand Ignition	Yes	Yes	Yes	Yes
Gas safety technology	Yes	Yes	Yes	Yes
Oven Light	Yes	Yes	Yes	Yes
Timer	Yes (digital)	Yes	Yes	Yes
Oven tray	Yes	Yes	Yes	Yes
Dripping pan	Yes	Yes	Yes	Yes
Voltage (Volt)	220 – 240	220 – 240	220 – 240	220 – 240
Product dimension (L x W x H) mm	595 x 630 x 595	595 x 630 x 595	595 x 630 x 595	595 x 630 x 595
Cut-out dimension (L x W x H) mm	560 x 570 x 580	560 x 570 x 580	560 x 570 x 580	560 x 570 x 580

*Specifications of this appliance may change without notice to improve the quality of the product. Pictures in this manual are schematic and may not match your product exactly. Values stated on the machine labels or in the documentation accompanying it are obtained in laboratory in accordance with the relevant standards. Depending on operational and environmental conditions of the appliance, values may vary.

APPENDIX 1

Cooking Type	Oven temperature (°C)	Cooking time (minutes)
Cake	175	40 – 50
Sponge cake	170	30
Fruit tart	180 – 190	20 – 30
Paradise cake	160	40 – 45
Margaret cake	160	40 – 45
Chocolate cake	160	25 – 35
Meringue	100	90
Puff pastry	200	20
Roasted beef – 1.5 kg	190	20 – 25
Roasted veal – 1 kg	150 – 160	30 – 35
Roasted lamb – 1.5 kg	190	30
Roasted pigeon	150 – 160	45
Turkey – 2 kg	175	180 – 240
Goose – 4 kg	200	240 – 270
Duck – 2.5 kg	175	90 – 150
Chicken – 1.5 kg	175	120 – 150
Trout	200	15 – 25
Cod-fish	190	50
OTHER		
Lasagna	200	40
Soufflé	180 – 200	20
Pizza	200	20

APPENDIX 2

Food will be grill	Time (minute)	
	1st Side	2nd Side
Sliced meat	6	4
Thick meat	8	5
Smal Fish	10	8
Big Fish	15	12
Sausage	12	10
Grill Sandwich	5	2
Small chicken	20	15



PT MODENA INDONESIA

Jl. Industri Raya I Blok D-8,
Jatiuwung, Tangerang 15135