

User Manual Book Wall Chimney Hood

CX 9150

CX 6150

CX 7110 L

CX 9701 L

CX 9777

CX 9754

CX 7754

CX 7712 L

CX 9313 L

CX 7310 L

CX 9313 S

CX 7313 S

CX 9301

CX 6301

CX 6330

CX 9330

CX 9356

CX 9177

CX 9157

CX 9156

CX 9753

CX 8917 LASS

CX 7915 GXBK

CX 8717 LASS

CX 7917 LABK

CX 7917 QABK

CX 7917 QAGY

TABLE OF CONTENTS

Part 1: Safety Warnings	3
Part 2: Name of Parts	4
Part 3: Installation	11
Part 4: How to Use	30
Part 5: Maintenance	50
Part 6: Problem & Solution	52
Part 7: Precaution	53
Part 8: Specification	53

This guidebook explains everything you need to know about your new product. Please contact our Customer Care should you need further assistance through www.modena.com

PART 1: SAFETY WARNINGS

- Do not allow children to operate the unit.
- This exhaust hood is designed for home use only, not suitable for the environmental condition, bake shop, barbecue, and other commercial purposes.
- The exhaust hood should be cleaned periodically so that its power is maintained.
- Clean the exhaust hood according to the instructions contained in this book and keeps it away from the danger of being burnt.
- No direct grilling on a gas stove.
- Keep your kitchen remains good circulation.
- Before connecting the unit to a power source, make sure the power cord is in good shape. If there is damage to the power cord, the replacement must be performed by qualified personnel or contact the MODENA Service Center for replacement process.
- The room should have good ventilation during the use of exhaust hood on gas stoves or other fuels.
- The exhaust hood waste pipe should be separated with an air-duct.
- Regulations regarding the air exhaust must be met.
- The unit is not intended to be used by persons (including children) with a physical, sensory, or mental disability, or lack of experience and knowledge unless they have been given supervision or instructions concerning the use of the appliance by the person who is responsible for their safety.
- Children should be supervised to ensure that they are not playing with the unit.
- Do not strike a fire under the sucker of the exhaust hood.
- The exhaust hood is not aimed to be installed on top of the stove that had more than four burners.

Electrical Shock Hazards

- Connect the unit only to a grounded power socket correctly. If you are in doubt, ask advice from an experienced technician who is suitably qualified.
- The failure to follow these instructions may cause electric shock, fire, or other hazards that are fatal.

PART 2: NAME OF PARTS

CX 9313 S, CX 9313 L, CX 7313 S, CX 7313 L, CX 9330, CX 6330, CX 9301, CX 6301

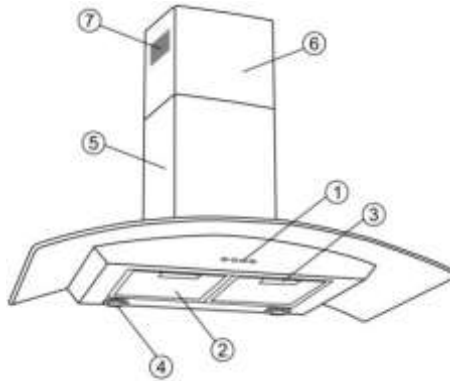

1. Control Panel
2. Cassette Aluminum Filter
3. Cassette Aluminum Filter Handle
4. Lamp
5. Main Chimney
6. Upper Connector Chimney
7. Circulation Hole

CX 9150, CX 6150, CX 7110 L, CX 9156

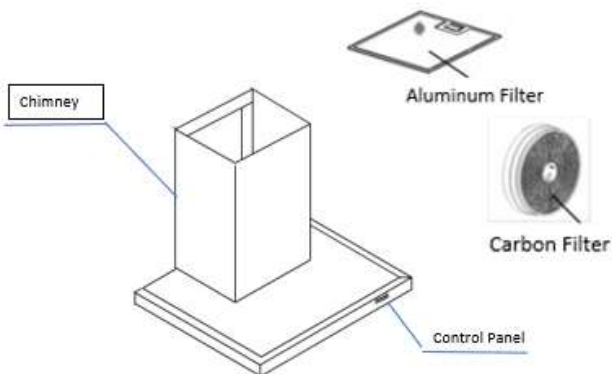

CX 9753

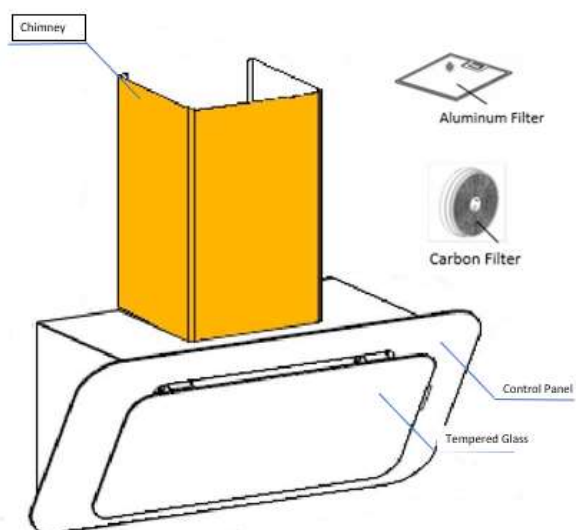

CX 9356

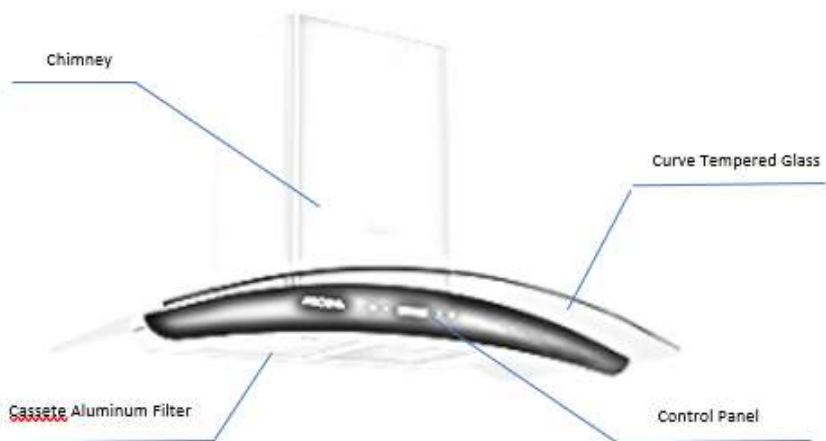

CX 9701 L

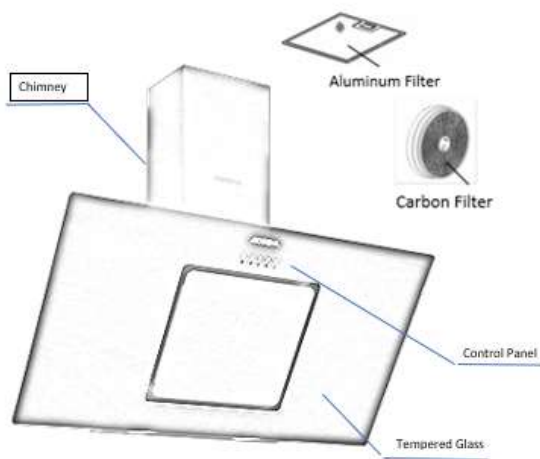

CX 7712

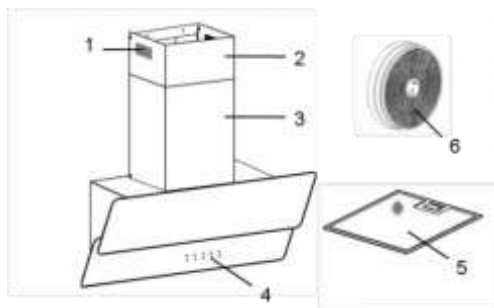

1. Circulation Hole
2. Upper Chimney
3. Main Chimney
4. Control Panel
5. Aluminum Filter
6. Carbon filter

CX 9777

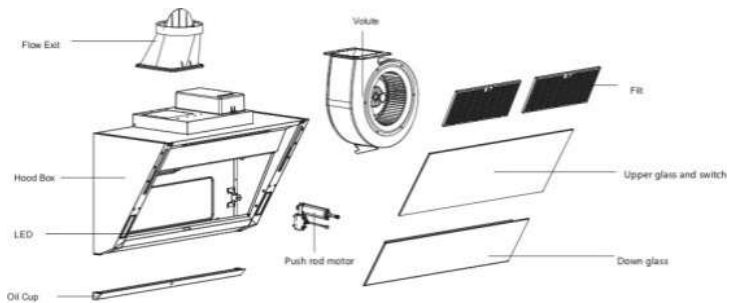

CX 9157/ CX 9177

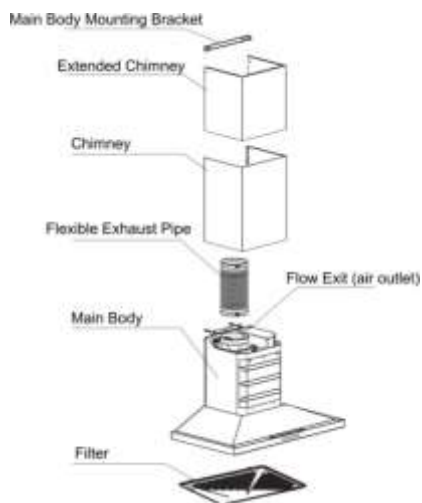

CX 9754 & CX 7754

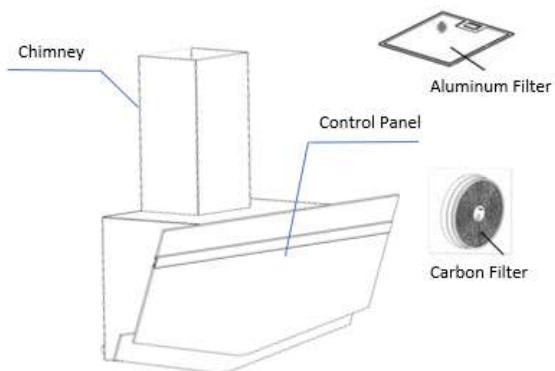

CX 8917 LASS

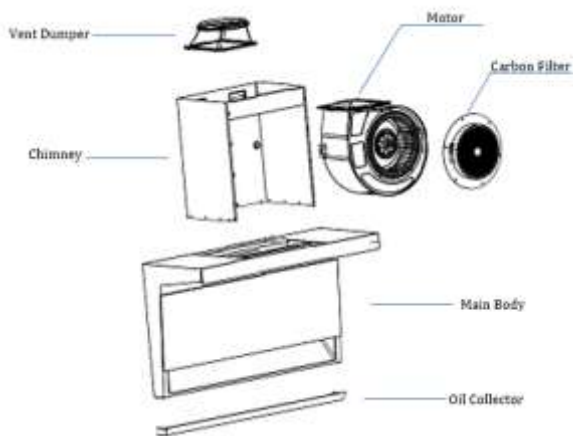

CX 7915 GXBK

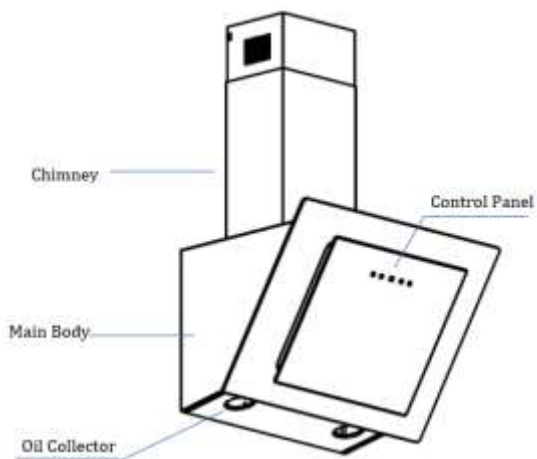

CX 8717 LASS

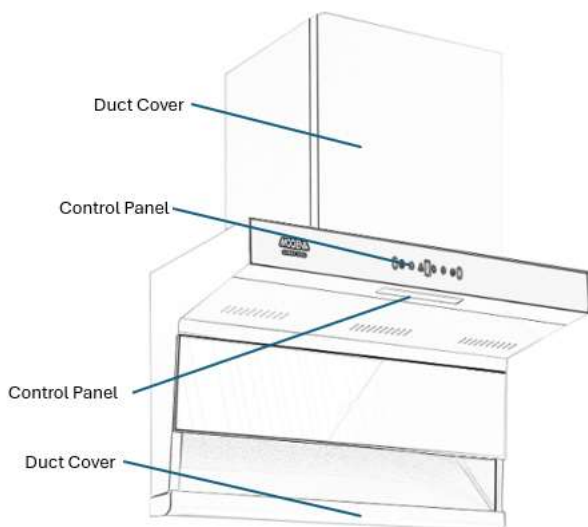

CX 7917 QABK & CX 7917 QABK

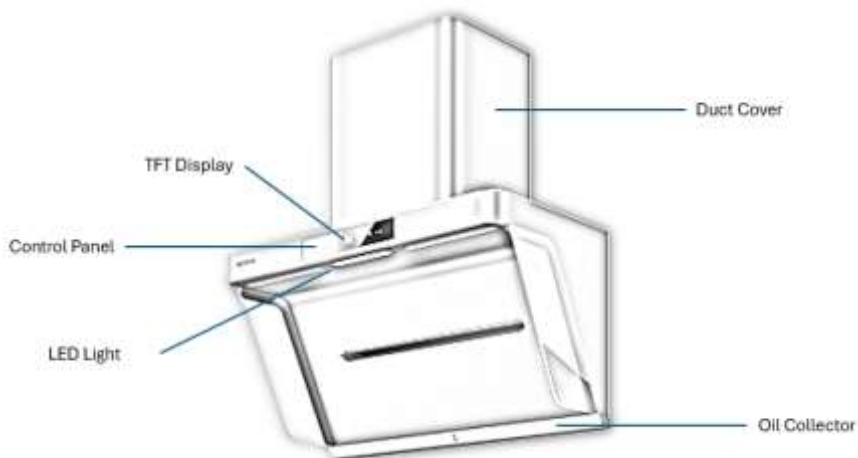

CX 7917 LABK

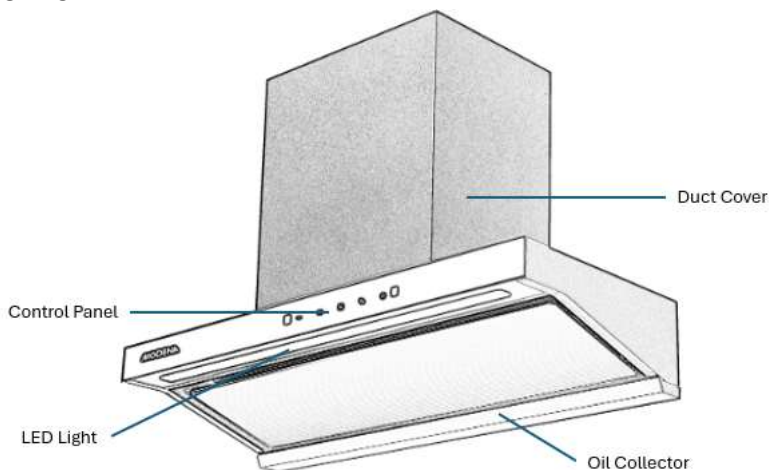

- The image is a general overview and is not necessarily the same as the product you receive.
- Features and other attributes are depending on the type of products

PART 3: INSTALLATION

Preparations of installation:

The exhaust hood is equipment which vacuums the smoke and odor produced in cooking process. With an exhaust hood, your kitchen will be free from oil particles which produces bad odor.

- If you have a waste pipe outside, the exhaust hood can be connected using extraction duct (enamel, aluminum, flexible pipe or a fire-resistant material with an inner diameter of 150 mm), see the following picture:

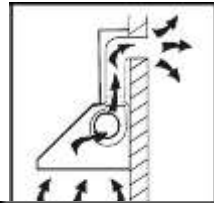

- Before installation, switch off the unit and unplug the power cord from the power socket

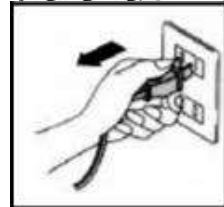

- Check the strength of wall on which the hood is to be installed. Make sure the wall can sustain the weight / load of the hood.

- The hood should be installed precisely over the stove at a vertical distance of 65 - 75 cm from the stove surface.

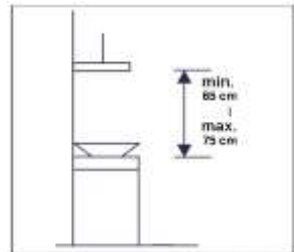

Installing the Hood on Wall

The hood must be installed in an upright position to prevent the oil from flowing to one side and dripping out of the exhaust hood.

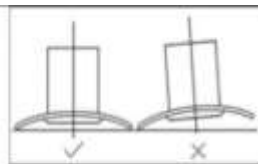

Creating Holes on the Wall and Methods for Installing Bracket

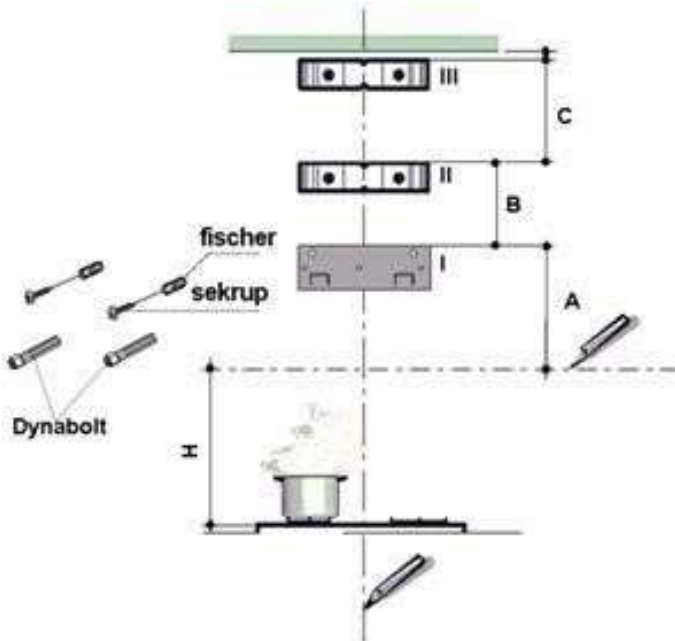

Model	A (cm)	B (cm)	C (cm)
CX 9753	37.5	39	39
CX 9330	34.5	20.5	49
CX 6330	34.5	20.5	49
CX 9150	34.5	20.5	49
CX 6150	34.5	20.5	49
CX 7712 L	25	39	39

NOTES

- Height / distance are 65 – 75 cm, except for CX 9753 type where the height / distance is 35 – 40 cm.
- For CX 7712 L, the height H is 34 – 45 cm
- For CX 9754 / CX 7754 the height is 34 – 45 cm
- For CX 9753, we recommend installation for use with a stove without the top cover.
- Height / Distance C can be shortened in accordance to the ceiling height.
- Make a vertical line on the wall to its highest point or to an appropriate height on the center part of the area where the vent hood is to be installed
- Make a horizontal line at H (cm) distance from the stove to mark the lowest limit for the hood.
- Install bracket I on the wall just like on the picture above up to height A and mark the holes for expansion bolt and plastic wall anchor. Especially for CX 9753, attach the unit on the wall up to height A and mark the holes for expansion bolt/plastic wall anchor/screw.
- Install bracket II on the wall just like on the picture above up to height B and mark the holes for plastic wall anchor hole.
- Install bracket III on the wall just like on the picture above up to height C and mark the holes for plastic wall anchor hole.
- Drill the wall with a \varnothing 10 mm for expansion bolt and \varnothing 8 mm for plastic wall anchor in all marked sections.
- Insert the expansion bolt and plastic wall anchor into the hole.
- Install all brackets using nut for expansion bolt and screw for the available plastic wall anchor

Installing the Hood Body

- Install hood's body on the bracket I on the wall or on the screw head especially for CX 9753.
- Connect the exhaust system with the spigot / flange if the exhaust hood will be operated in a ducting / exhaust system.

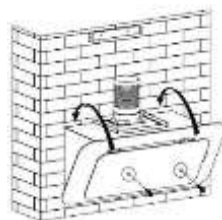

- Install the main chimney and the upper chimney on brackets I and II with the screws that already provided.



Working Method

MODENA exhaust hood has 2 principle of work:

Ducting system:

In this mode, the hood operates by sucking the smoke / odor in the cooking process and then releasing it out of the vent through the exhaust system.

To connect the hood with the duct system, use “ spigot/flange “ which is designed with a diameter of 150 mm.

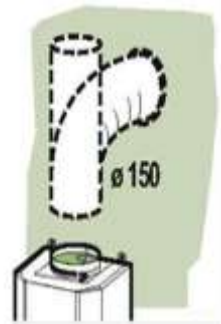

Several things which require attention in installing the ducting system exhaust hood:

1. Carbon filter must be removed. Only use the aluminum filter.
2. If the hood is installed in a multi-storied building or an apartment, consult with the person in charge of the building / apartment prior to installing the exhaust system.
3. Hood with ducting system should be used in an open-air room with good air circulation.

Recirculating System

In this version, the vent hood sucks the smoke / cooking odor and filters it through an aluminum filter and carbon filter. The filtered smoke is then reticulated into the room. This system is used if the premise renders it impossible to install a ducting system

Several things which must be ensured when installing a vent hood with reticulating system:

1. Both carbon filter and aluminum filter must be used.
2. The position of both filters must be precise.
3. Circulation holes on the exhaust hood are not allowed to be closed

Installation (Ducting System)

When the range hood and appliance supplied with energy other than electricity are simultaneously in operation, the negative pressure in the room must not exceed 4 Pa (4×10^{-5} Bar)

- Drill 3 x 8mm holes to accommodate the bracket. Screw and tighten the bracket onto the wall with the screws & screw plugs provided

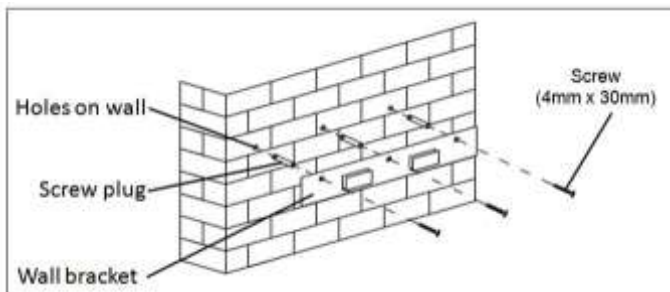

- For inclined panel Model, need to drill 4 x 8mm extra holes & fixing screws & screw plugs before installation.

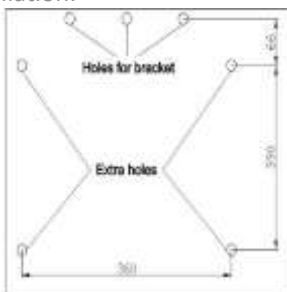

- Leave up the exhaust hood and hang onto the wall bracket hook.

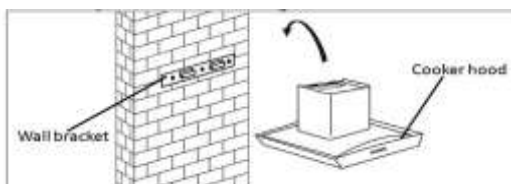

- Fix the one-way-valve to the air outlet of the exhaust hood. Then, attached the exhaust pipe into the one-way-valve as shown below.

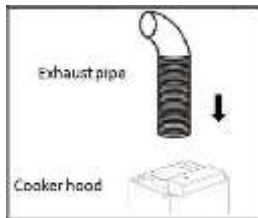

Installation (Re-circulating System):

- If you do not have an outlet to the outside, exhaust pipe is not required and the installation is similar to the one show in section “ Installation (Ducting/Exhaust System) “ .

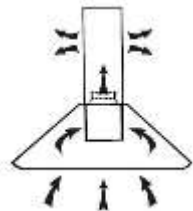

- Activated carbon filter can be used to trap odors.
- In order to install the activated carbon filter, the grease filter should be detached first by press the lock and pull it downward.

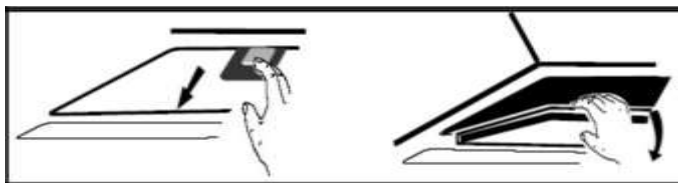

- Plug the activated carbon filter into the unit and turn it in clockwise direction. Repeat the same on the other side

NOTE

- Make sure the filter is securely locked. Otherwise, it would loosen and cause dangerous.
- When activated carbon filter attached, the suction power will be lower.
- Carbon filters are installed at the rear of the grill and had to be replaced after three months or depends on someone using cooker hood.



Chimney installation

For the Glass model and T shape model

- By put the upper chimney into lower chimney. Then pulling out the upper chimney upwards. Adjust to reach the height required.

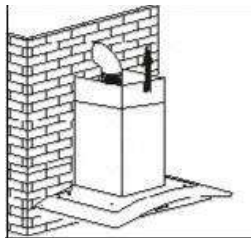

- Sliding the chimney to adjust the chimney height. When the height you required is reached, then hang the fixing hole to the fixing screws as showed in below pictures

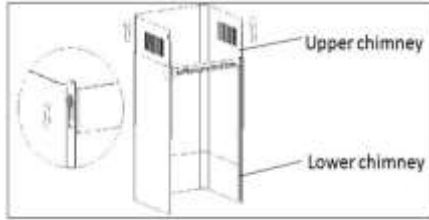

- Drill 2 × 8 mm holes to accommodate the plate II. Screw and tighten the plate II into the wall with two screws provided. Assemble the chimney into the unit and fix it with two screws

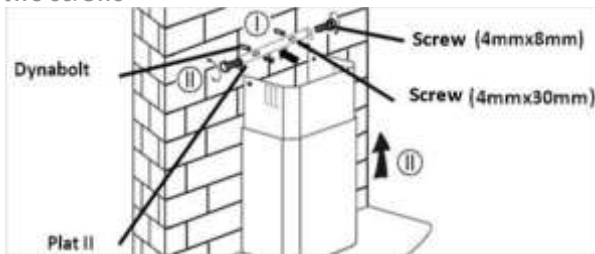

For Tower Model

- Put the inner chimney into upper chimney. Then pulling out the upper chimney upwards. Adjust to reach the height required



- Fix the lower chimney with two pieces of 4x8 mm screws

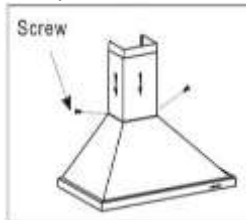

- Sliding the chimney to adjust the chimney height. When the height you required is reached, then fix two pieces of 4x8 mm screws onto the hole fixing with plate I as showed in below pictures

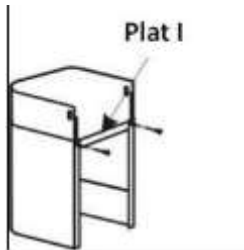

- Drill 2 x 8 mm holes to accommodate the plate II. Screw and tighten the plate II into the wall with two screws provided.

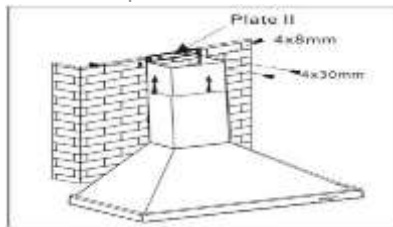

- Assembly the chimney into the unit and fix it with two screws.

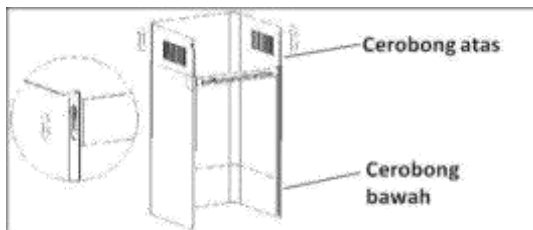

For optimal air extraction :

- Keep exhaust duct short and straight.
- Do not reduce the size or restrict the exhaust duct.
- Minimize bends.
- Make sure the helix of the flexible exhaust duct is tightly drawn rather than slacking.
- Determine height between cooker hob and base of hood.
- Mark wall to suit all bracket locations. Drill holes of 50 mm depth at the selected drilling position.

- Insert the expansion tubes to fix the bracket onto the wall.
- Install the flow exit to the hood and follow by connecting the flexible exhaust duct to the flow exit.
- Strengthened the connection between the flow exit and the flexible exhaust duct with screws.
- Lift and hang the hood to the wall bracket and please ensure it sits firmly on the bracket.
- Direct the other end of the flexible exhaust duct to the outlet or wall.
- Fit in the safety baffle of the hood onto the wall to strengthen the position and to reduce vibration when the hood is switched on.
- Chimney extension can be installed to the ceiling or wall.
- Ensure the oil collection container is in place before the hood is being used. To remove it for cleaning, slide the oil collection container from front to rear, vice versa for inserting it into position
- Ensure there is proper ventilation in the cooking area.
- Instructions concerning the discharge of air have to be followed.
- Does not use flame under the range hood.
- Avoid using materials which could cause spurts of flame near the range hood.
- Never touch the lamp when it is on.
- Do not dismantle, repair or modify the range hood on your own.

CX 8917 LASS

- Determine the installation position
The hood should be installed horizontally above the hob.
- Install the wall bracket
Drill 4 holes of ϕ 10 in the wall according to the size of the wall bracket with a depth of 60mm, bury the plastic expansion tube in the holes and fix the bracket with ST4.9X50 screws.
- Install the vent damper assembly and ducting hose
Fix the vent damper assembly on the range hood with the screws at the air outlet, and check whether they are installed properly.
Insert the ducting hose into the vent damper assembly, fasten the pipe with two ST3.9X10 screws and seal it with transparent adhesive to prevent fume leakage.

- Hood installation

Hang the hood on the fixed wall bracket and make sure it is securely in place, then screw the anti-dislodging screws. Lead the ducting hose out, and install the oil collector.

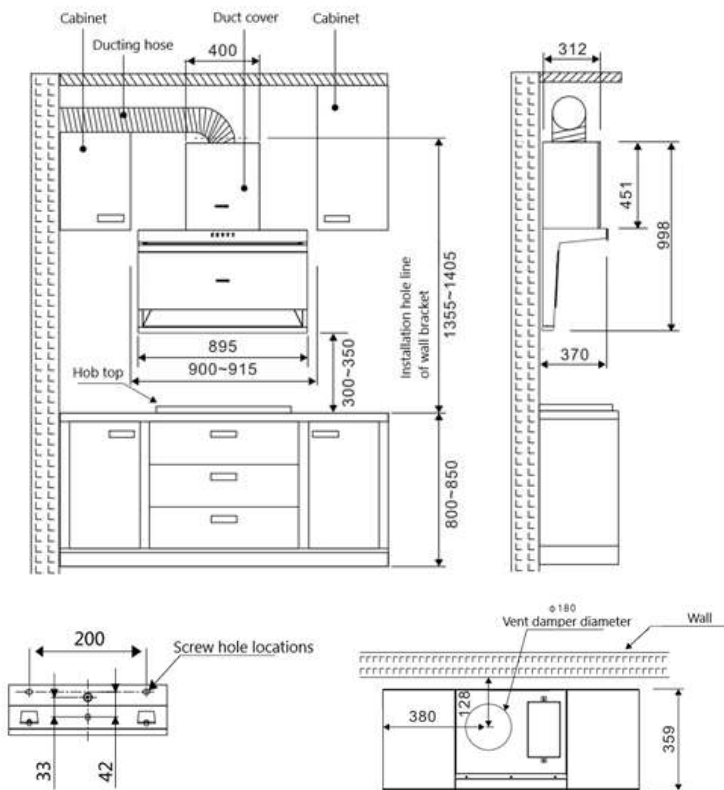

CX 8917 LASS

- Determine the installation position
The hood should be installed horizontally above the hob.
- Install the wall bracket
Drill 4 holes of $\phi 10$ in the wall according to the size of the wall bracket with a depth of 60mm, bury the plastic expansion tube in the holes, and fix the bracket with ST4.9X60 screws.
- Install the vent damper assembly and ducting hose
Unscrew the four M4X18 cross-slot pan head screws at the air outlet of the range hood, place the non-return valve at the air outlet of the range hood, and fasten the non-return valve to the case of the range hood with the unscrewed four M4X 18 cross-slot pan head screws.
Fasten the corrugated exhaust pipe with two M4X8 flat tapping screws to the top of the check valve, and then lead it out as shown in the figure. If possible, bend the corrugated pipe at an angle of not less than 120° .
The part of the pipe that extends to the outdoor or public flue should be avoided as much as possible to avoid direct blowing of natural wind, so as not to reduce the effect of exhausting grease and smoke.
The gas from the hood should not be discharged into the hot flue used for exhausting fumes from burning gas or other fuels.
- Confirmation after assembly
After the installation is completed, turn on the power to carry out the test run of the cooker hood to check whether the functions of the cooker hood are normal and whether there is any abnormal vibration of the body, and confirm that there is no error before use.

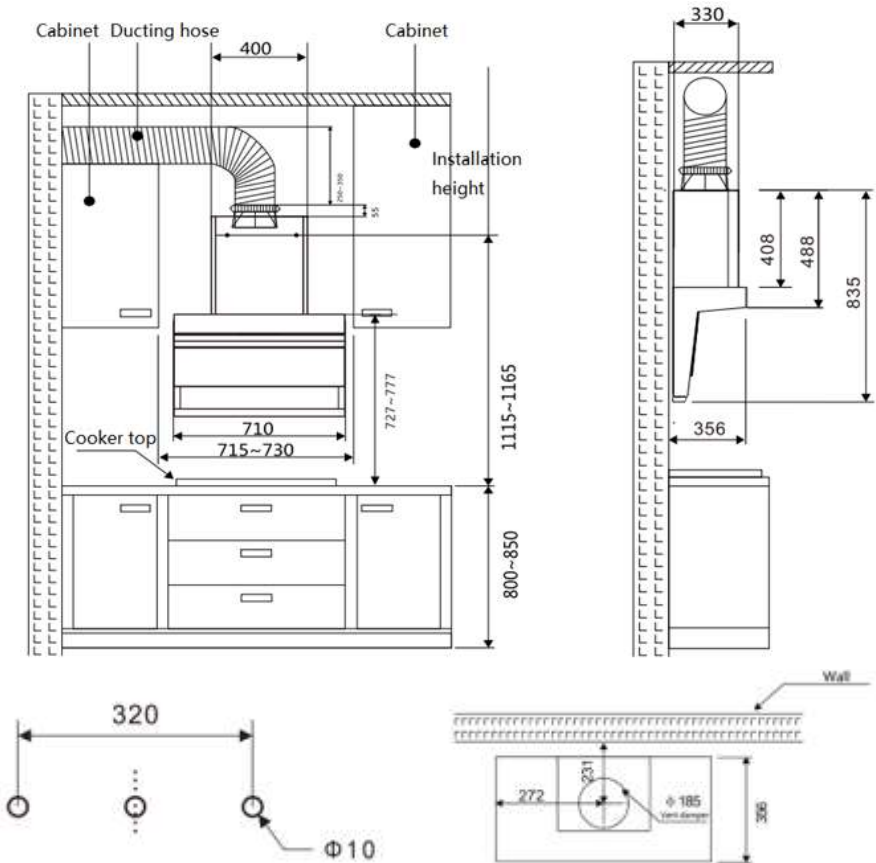

NOTES:

- When drilling holes for expansion tubes, the diameter of the holes should be the same as the tube size. Drilling large holes will cause the expansion tubes to loosen and accidental fall of hood.
- If installed above gas hob, the height should be 650 -750mm
- Avoid excessively long ducting hose to affect the extraction effect.
- Power sockets should be less than 1000mm away from the hood.

CX 7917 LABK

- Determine the installation position

The hood should be installed horizontally above the hob.

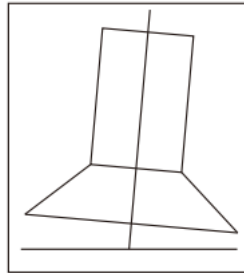
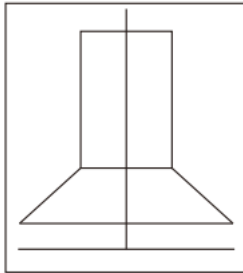

NOTES:

Make sure the range hood is hanging vertically and horizontally. Do not hang it on the tilt way.

- Preparation and confirmation before installation
 - Wall Strength
The wall that the range hood is placed on must be hard enough to bear the weight of range hood.
 - Height of Mounting
The suitable height of mounting shall be 650-700mm above the cooking stove. The real installation height is subject to the construction of kitchen and user's height. The installation instruction of gas stove has given the suitable installation distance, please take it into consideration.

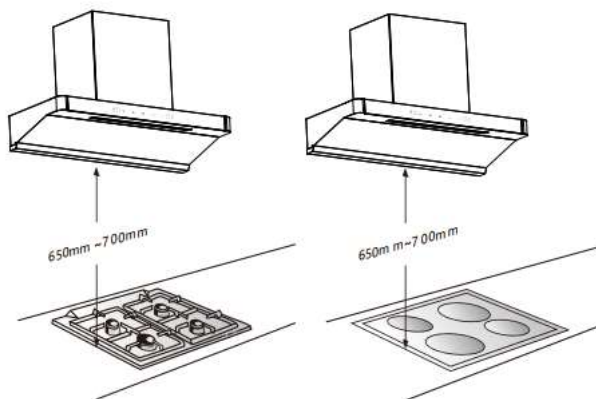

- Installation Hanger / Bracket
 - Measure the installation height
 - Mark the position of hanger/bracket on the wall
 - Drill holes for fixing hanger/bracket
 - Punch plastic expansion bolts into the holes
 - Fix the hanger

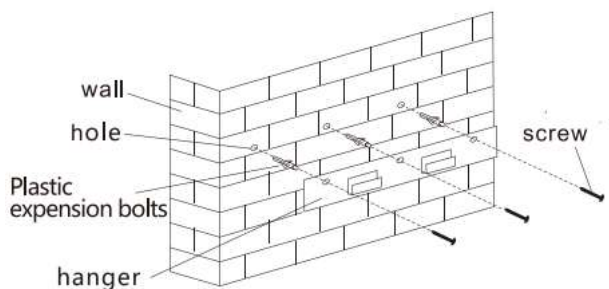

Hanger installation

- Product Installation
 - Aim at the hanger/bracket and hang the range hood up on the wall
 - Connect the one end of exhaust pipe diameter 153 mm to exhaust hole of range hood and the other end connect to air outlet.

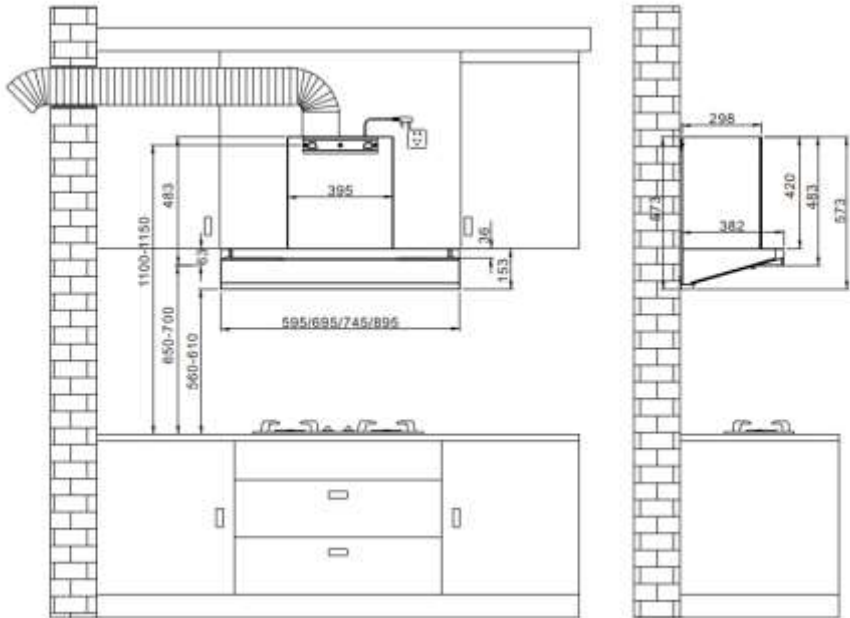
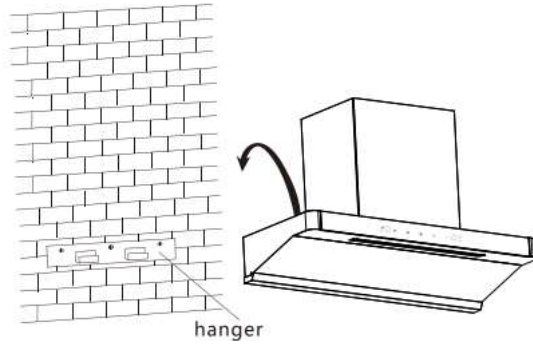

- Exhaust Pipe connecting to the wall outside
The other head of exhaust pipe shall be connected to the flue or the hole of wall outside (diameter of hole shall be 170 mm)

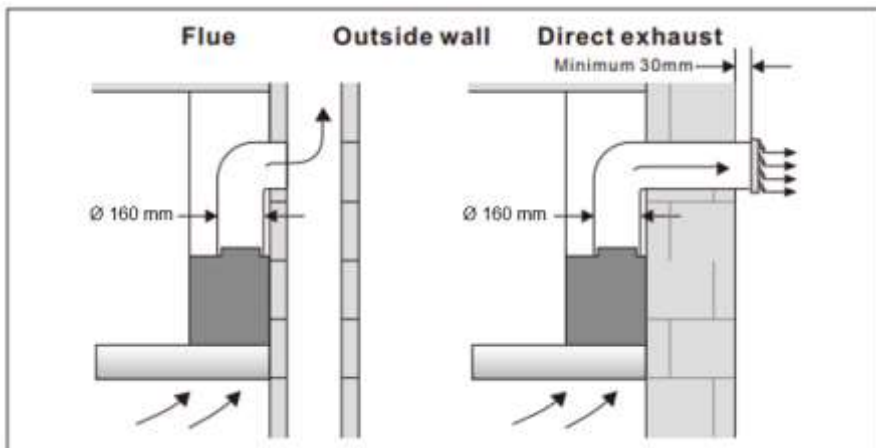

- Confirmation of installation
After installation, connect to power supply and turn on the range hood. Check if all functions of range hood are working normally, no abnormal vibration and no resistance to leaves of air outlet.

CX 7917 QAGY & CX 7917 QABK

- Determine the installation position
The hood should be installed horizontally above the hob.

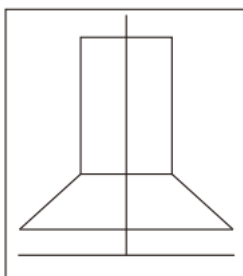

✓

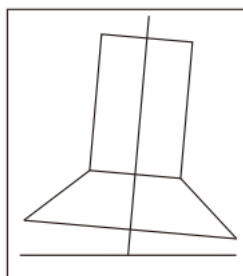

X

NOTES:

Make sure the range hood is hanging vertically and horizontally. Do not hang it on the tilt way.

- Preparation and confirmation before installation
 - Wall Strength

The wall that the range hood is placed on must be hard enough to bear the weight of range hood.
 - Height of Mounting

The suitable height of mounting shall be 650-700mm above the cooking stove. The real installation height is subject to the construction of kitchen and user's height. The installation instruction of gas stove has given the suitable installation distance
- Installation Hanger / Bracket
 - Measure the installation height
 - Mark the position of hanger/bracket on the wall
 - Drill holes for fixing hanger/bracket
 - Punch plastic expansion bolts into the holes
 - Fix the hanger

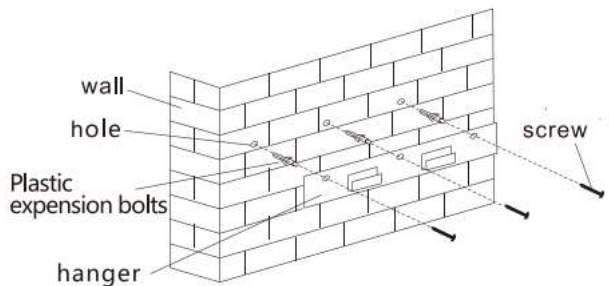

Hanger installation

- Product Installation
 - Aim at the hanger/bracket and hang the range hood up on the wall.
 - Connect one end of exhaust pipe diameter 180 mm to exhaust hole of range hood and the other end connect to air outlet.

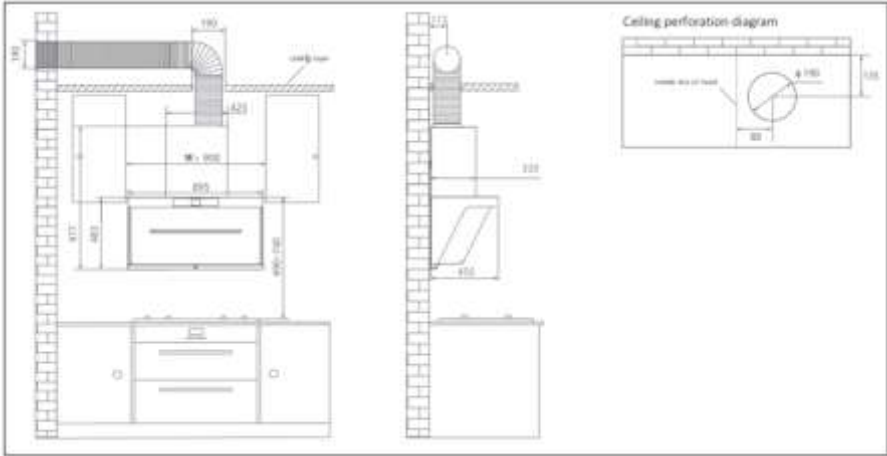

- Exhaust Pipe connecting to the wall outside
 The other head of exhaust pipe shall be connected to the flue or the hole of wall outside (diameter of hole shall be 190 mm)
- Confirmation of installation
 After installation, connect to the power supply and turn on the range hood. Check if all functions of range hood are working normally, no abnormal vibration and no resistance to leaves of air outlet.

PART 4: HOW TO USE

NOTES:

Adjust the motor speed of the exhaust hood according to the thickness of smoke / steam generated in the cooking process.

Push Button



OFF / 0 To switch off the Hood



Activate Motor at Low Speed



Activate Motor at Medium Speed



Activate Motor at High Speed



To Turn On/Off the Light

Electronic Button + Display



To Turn On/Off the Hood



To Adjust the Motor's Speed (Low Medium-High)



To Activate the Shut-off Timer (After 9 Minutes motor will switch off automatically)



To Turn On/Off the Light

Touch Button

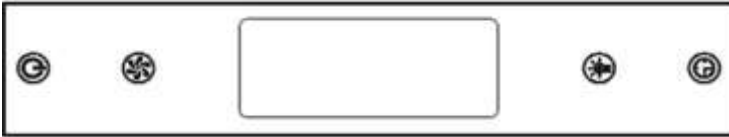

To Set the Usage Time



To Turn On/Off the Light



To Adjust the Speed Level (Low-Medium-High)









To Turn On/Off the Hood

If the button is pressed, the unit will work in which the motor speed depending on the last setting

Clock Setting



The default setting for the time when it was first turned on is 12:00 PM. If the power is not connected or cut off, the unit will return to the initial setting is 12:00 and you have to reset.

To set the clock can be done when the motor and lights are not in working condition. The way to setting the clock as follow:

1. Touch the button  around 2 until 5 seconds, the display will show, the first two digits will blink indicates for setting of the hours. Then adjust with touch the  button to increase or the touch  to decrease. The largest value for hour is 23 and will not working if it is exceeded 23 and function  will not working if it has reached the lower limit of 00. The addition value by every touch is 01.
2. Touch the  button once more for 2 until 5 seconds, the display will show **88:88** the last two digits will blink which indicates to set the minute. Then adjust it by touching the button to increase or the button to decrease. The largest value for minute is 59 and will not working when it is exceeded 59 and function  will not working if it reached the lower limit of 00. The addition value by every touch is 01.
3. Press the  button one more time to finish the Clock's Setting

Setting the Timer

The Timer can be set when the motor or lamp is on. Timer duration is set in three periods: 5 minutes/ 15 minutes / 30 minutes/ Cancel.

1. To set the timer, touch the button  once for 5 minutes, twice for 15 minutes, thrice for 30 minutes, four times to cancel, five times for 5 minutes and so on. After the timer's time is finish, the motor and lamp will turn off automatically.
2. To change an ongoing timer, touch the  for 5 seconds or until the correct time is displayed.

Touch control





After plug in power, it will automatically sets in standby mode



Timer's Button

Times setting keep pressing it while in standby mode to enter time setting, hour display will flash, press **+** or **-** to set the time.

Press  to change into minute setting, press **+** or **-** to set the time, press  again or wait 10s to finish the time setting.

Timer setting, short press during working mode, pre-set cycle:
off→15mins→30mins→45mins→off:

off→15menit→30menit→45menit→off.

Press **+** or **-** to adjust the time unless when the timer setting is “ off “



Speed increase button



Speed decrease button



Light button

LCD Display



1. Fan symbol will be active when the fan is working
2. Time display
3. Timer
4. Light
5. Fan speed
6. Alarm symbol
7. Active buzzer carbon replacement symbol

Operating Instructions

- Confirm that when the hood is installed, plug in the power cord, and the hood sends out a “drip” sound, indicating that the power is connected.
- Please use the following methods for the first time. If there is any discrepancy, please contact the local distributor or service department as soon as possible

CX 9777

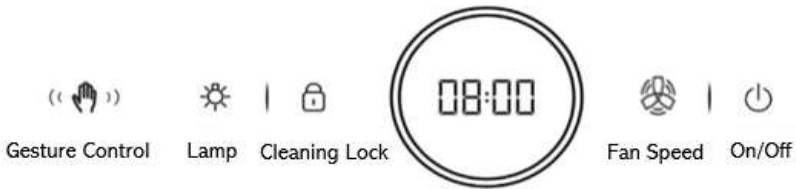

- To start the hood, press the wake button first and then touch the ring with clockwise touch. The wind is changed from small to large, when the whole ring is red when it starts to suck, it keeps running for 3 minutes.
- All the display lights up for 1 second and then goes out. The buzzer sends out a “bite” prompt, and the whole machine enters the shutdown state.
- Gesture control: When the machine is shut down, the palm swings from left to right or from right to left once, and the hood starts. The fan runs in strong gear and the lighting is turned on at the same time.
- Power key: for switch/delay operation. When shutdown operation is invalid, press this key to shut down or enter a delay of 3 minutes.
- Super suction key: Used to set the air volume of hood. The super-strong suction time is 3 minutes, after 3 minutes, it will automatically turn into strong-gear operation state.
- Lighting keys: used to turn on or off lights
- Cleaning Lock Screen Function: Press the Lighting keys for 3 seconds to enter the cleaning lock screen state, and press 3 seconds to exit the cleaning lock screen.
- The indicator light of “strong key” keeps flickering; the hood enters the state of cleaning lock screen. Press the “strong key” for 3 seconds to exit the lock screen. The buzzer whistles and the panel close.
- Clock display: In the state of clock display, press the power key for a long time. Start flickering in the hourly area, press the “weak” or “strong” button
- Adjust the clock. After setting the hour, press the “power” button, switch to the minute area and start flickering. Adjust the minute and press again.
- After 3 seconds, save the clock settings.

CX 9157/ CX 9177



- **Gesture control:** When the hood is off, use your hand to wave from right to left above the icon once; the hood will start to work immediately. At the same time, the light will be turned on. When the hood is working, use your hand to wave from left to right above the icon once, the hood will stop working immediately. At the same time, the light will be turned off.
- **Illumination:** Touch the icon to turn on the light and touch one more time to turn off the light.
- **Boost:** Touch this icon once and the hood will start to work in the state of boost for 3 minutes and then change to work at high speed. If you want to make the hood work at boost state again, touch the icon one more time.
- **Time/display:** In the state of time/display, touch and hold the icon “ On/off “ , “ hour “ area will start to flash, and you can touch “ Boost “ or “ High speed “ to adjust the “ hour “ digit. After the “ hour “ digit is set, touch the “ On/off “ icon, then “ minute “ area will start to flash and you can adjust the “ minute “ digit as that of “ hour “ digit. After finishing clock setting, touch and hold “ On/off “ icon for 3 seconds to keep the setting.

CX 8917 LASS & CX 8717 LASS

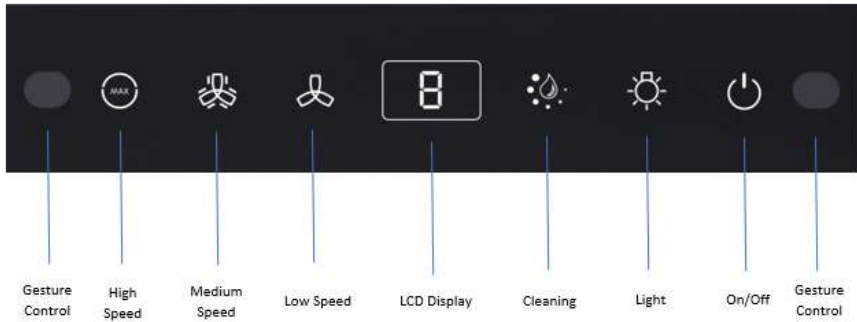

After the power is turned on, all the button indicators and the display will illuminate for 1 second, the buzzer will sound. In standby mode, if there is no operation for 2 minutes, the hood will automatically return to the off mode

Low Speed

Touch the “ Low speed ” button, the display shows 1 and motor works in low speed; touch it twice, the hood is turned off.

Medium Speed

Touch the “ Medium speed ” button, the display shows 2 and motor works in medium speed; touch it twice, the hood is turned off.

High Speed

In standby mode, touch the “ High speed ” button, the button indicator light flashes and display shows “ 3 ”, motor runs in high speed for 2 minutes. It will automatically enter the “ Medium speed ” after 2 minutes, the display shows “ 2 ”.

Cleaning

Touch the “ Cleaning ” button for 3s to enter 6min heat cleaning. Air dry (in Medium speed) 3min after the automatic shutdown, at this time the display “ cleaning “ cleaning “ icon is always on; in the cleaning state, long press the “ cleaning “ key for 3s to end the cleaning

Light

Touch the “ Lighting “ button to turn the lighting on or off.

On/Off

When Cooker hood off, touch the “ On/Off “ button, the display will illuminate.

In standby mode, touch the “ On/Off “ button, the “ On/Off “ indicator goes out and the display off.

When the Cooker hood on, touch the “ Power “ button to enable the 3 minutes delay-off function and display shows a 3 minutes countdown. After 3 minutes the Cooker hood will power off. When the delay off function is on, the user can touch the “ Power “ button again to turn off the Cooker hood directly.

Gesture Control

Wave your hand once from left to right to enter low speed operation, the “ Low speed “ button indicator will illuminate and turns on the light.;

Wave your hand twice to enter medium speed operation, “ Medium speed “ button indicator will illuminate;

Wave your hand three times to enters high speed operation;



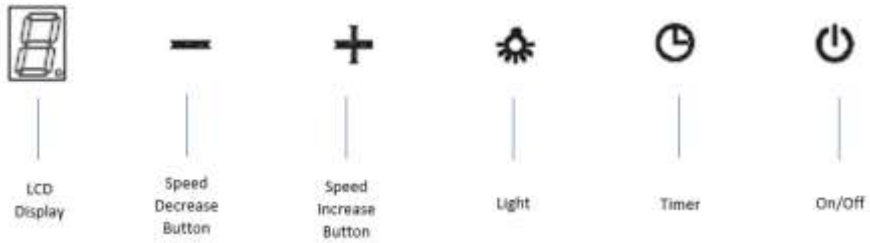

Wave your hand from right to left, it will turn the power off for entire hood. Touch the “ On/Off “ button for 3s, the gesture control function turns off.



CX 7915 GXBK



. On/Off

After connecting the cooker hood to the main supply, the indicators of all buttons will turn on. The LED display is closed. The cooker hood doesn't work and enter into stand-by mode.

Press  (On/Off) button, the indicator of this button will be on. The hood will work at low speed, the LED display will show " 1 " and the light will be on. The indicator of the buttons , , and  (Lamp) will be on. Press  (On/Off) button again, the indicators will be off and the functions of the cooker hood will be close and the hood returns into stand-by mode. The above steps can be operated repeatedly.

The  (Increase) button and  (Lamp) button could be operated without pressing the  (On/Off) button. When a certain function button is pressed, the hood operates at that function status, excluding timer function. Press power button under any status, all functions of the cooker hood will be switched off.

Light

Press  (Light) button, the lights will be on. The indicator light of lamp button and power button will lit on. Press again, the lights will be off. The indicator lights of lamp button and power button will be off. The above steps can be operated repeatedly.

Speed Increase Button

There are three speeds, including high, middle, low speeds.



Press  (Increase) button, the indicator light of this button will be on, the cooker hood starts to work at low speed. The LED display will display “ 1 “ .





Press  (Increase) button again when it is working at low speed, the cooker hood works at middle speed and the LED display will display “ 2 “ .

Press  (Increase) button again when it is working at middle speed, the cooker hood works at high speed and the LED display will display “ 3 “ .

Press  (Increase) button again when it works at high speed, the cooker hood will still work at high speed.

Speed Decrease Button

Press  (Decrease) button, the cooker hood will decrease one speed, and the display will show the current working speed. Press  (Decrease) button when it works at high speed, the cooker hood works at middle speed. The indicator lights

of the  (Increase) button,  (Decrease) button and  (On/Off) button will be on. Press  (Decrease) button when it works at middle speed, the cooker hood will work at the low speed. The backlights of the increase button, decrease button and power button keep bright. When continuously decrementing to no speed levels, the cooker hood will turn off and the indicator lights will be off.

Timer

The timer button is only used for the timer function when the hood is working. Press the button will be invalid when the hood is under standby mode or open the lamp separately. Press timer button once, the timer setting is 5 minutes and the indicator light of this button is on. Press again to close the timer function and the indicator light will be off. The timer could be repeat setting. When the time is up, the cooker hood will be turn off and the lights will be off.

When the timer is set, if adjusting the speeds, the timer will automatically exit

Modena Smart Apps Configuration

1. Install Modena Smart Apps on the smart phone
2. Connect the smart phone with WIFI Network
3. Open Modena Smart Apps
4. Follow the registration steps instructed by the Apps
5. Press + icon or Add Device icon
6. Select Kitchen Appliance on side bar
7. Press Kitchen Hood icon
8. Press the light button + Speed Increase Button together on the hood for a while until dot indicator on digital display blinking.
9. Select Wi-Fi Network and fill out password.
10. Press Confirm.
11. Wait for a few moments until it's finished.

NOTES:

UV Sterilwave will be work in the same time when turn on the lamp of cooker hood.

CX 9754 & CX 7754

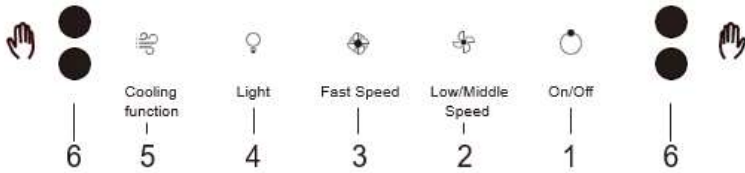



1. On / off key:When this key is touched in the off state,entering the standby state and waiting for other key operations;When you touch this key again, it returns to the off state.Time-delay function:when the motor is running,touch this key to enter a 1-minute time-delay shutdown state,the indicator light flashes during the delay.
2. Low/Middle speed key:Press this button when in the standby state, then the button will light up while the fan will enter the slow running state. Press the button once again, the fan enters a medium-speed running state. Press the button repeatedly to stop the fan and return to the standby state.
3. Fast speed key:Touch this key in standby state, the key lights up,and the fan enters the fast running state.Touch the key again to return to the standby state, and the fan stops running.
4. Light key: In any state, touch this key to turn on the light. When you touch this key again, the light will turn off. (The lamp is controlled independently, it can be turned off by manual shutdown)
5. Cooling function key: In any state, touch this key to turn on the Cooling function.
6. Gesture motion sensor:Wave your hand from left to right to turn on the cooker hood.The cooker hood will start to operate with high fan speed and LED light will turn on.Wave your hand from right to left to turn off the cooker hood.The cooker hood will stop operate and turn off immediately.

NOTED:

- When using gesture control ,please align your palm with sensing area
- The ideally gesture motion speed from left to right or right to left shall within two seconds
- The ideally distance of gesture motion from control panel is from 5 – 10 CM

Heat Cleaning Function

1. Press and hold the  button for 2 seconds to activate the heat cleaning function
2. The cooker hood will operate the heat cleaning function for 15 minutes
3. The indicator light will keep blinking.
4. Press and hold the  button until deactivate the heat cleaning function or press  button to deactivate this function.

CX 7917 QAGY & CX 7917 QABK



First time connected to power supply

All the buttons light up 1s then off, then “  ” keep lighting, the screen displays the initial time of 00:00

Light up

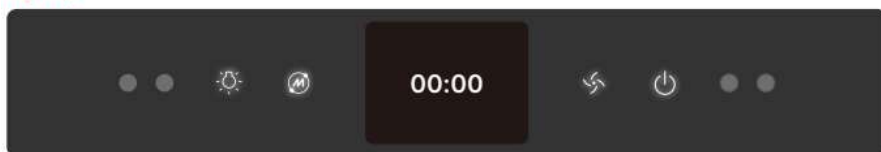

15 LATER

Standby state

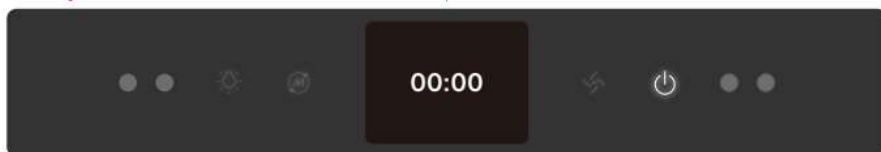

PM2.5 Visual interface

Here are three levels to show the PM2.5 range of the current environment.



Excellent



Good



Poor

Switch On /Off and main function buttons

Switch On

In the stand by state, touch “  ” to switch on, the light and low wind speed will turn on, the screen will show PM 2.5 detection state.

Standby state

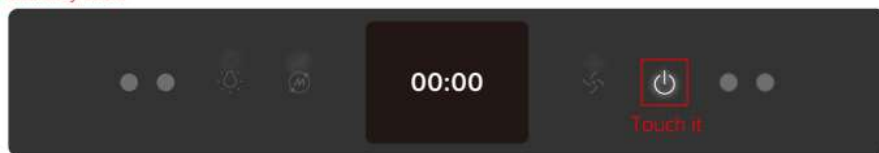

Switch on state



Switch Off



In the working state, touch “  ” to switch off, the machine will go into standby mode.

Switch on state

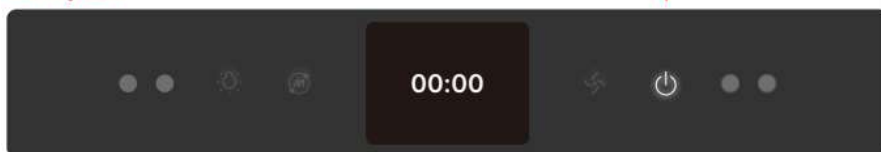

Standby state



In the working state, touch “  ” to switch off, and delayed shutdown mode is called, low down the wind speed automatically, the screen shows 3 minutes countdown, “  ” is flashing. The machine will enter the standby state after the countdown.

Switch on state





Delayed shutdown mode state

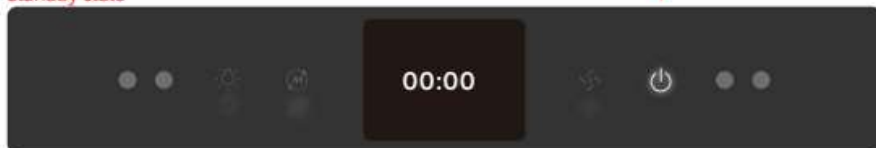

Standby state



Auto Delayed shutdown mode On/Off

In the standby state, touch and hold “” and “” 3 seconds at the same time. When you hear “BEE”, the mode is ON or OFF

Gesture Control

Wave your hand from left to right to increase fan speed & wave your hand from right to left to decrease fan speed.



Active / Deactive Gesture Control

In the standby state touch and hold “” and “” 3 seconds, then hear the “BEE”, and turn On / Off gesture control successfully.

Standby state



Hob & Hood Linkage

When hood in standby status, touch linkage button “” 3 times continuously to enter the linkage setting status, the linkage status indicator  is blinking, then rotate the two knobs of gas stove at the same time within 30 seconds. When the linkage is successful established, the linkage status indicator  will keep light up in the TFT Display.

Standby state * Cooker Hood *

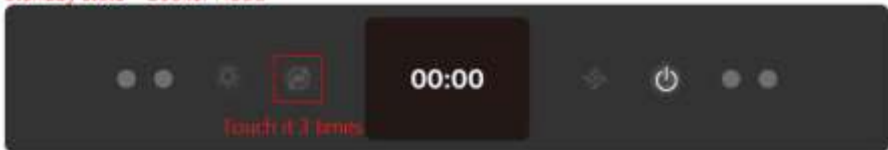

rotate two knobs on stove within 30s

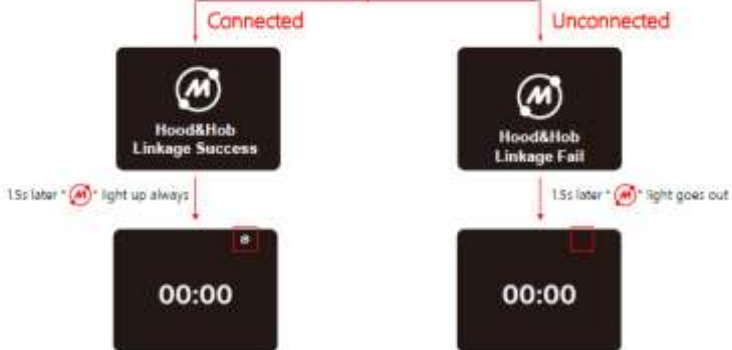



Disable Hob & Hood Linkage





Under linkage established status, touch linkage button  3 times continuously, and do not turn on gas stove within 30 seconds.

When the linkage status indicator disappears in the TFT display, the linkage status is disabled.



Time Setting

In a standby state touch and hold “” 3 seconds to enter time setting mode, when the “00:00” flashing, press “” to set minutes or hours

Press “” first time, “02:00” will flash, then press “”, choose “00-23”. Press “” again, “00:05” will be flashing, then press “” to choose “00-59”. 5 seconds without any operations, the machine will save time and quit out.

Standby state

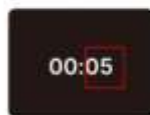
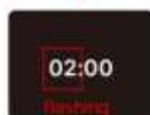
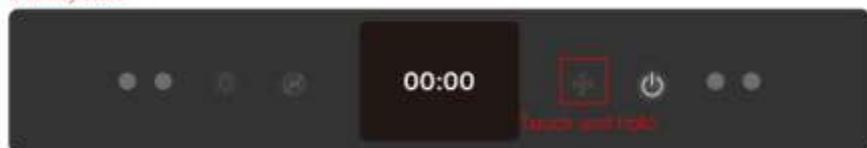





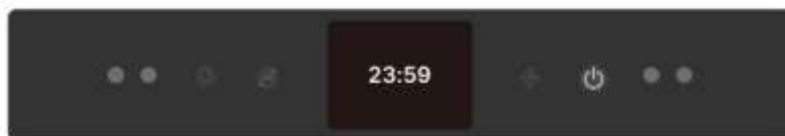

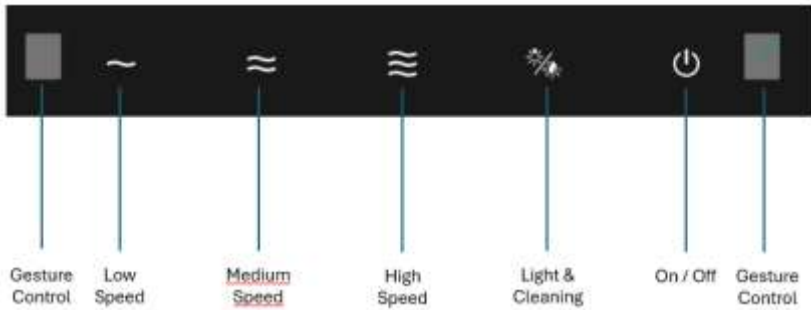

Touch and hold 2s to add 5 value

5s without any operations, machine will save the time and quit out.



CX 7917 LABK



- Touch On / Off “” button and the light on the control panel will come on and the cooker hood will now be in standby mode.
- Touch On / Off “” button for turn on , turn off or active auto delay shutdown function. Once the cooking is over, instead of switching off the product, touch the On / Off button. A reverse timer of 3 minutes will get active and the cooker hood will shut itself off after the end of this 3 minutes. If touch the On / Off button again, the cooker hood will be turned off at once.
- Touch “” button and the cooker hood will start operating at low - speed.
- Touch “” button and the cooker hood will start operating at Medium-speed.
- Touch “” button, and the cooker hood will start operating at High - speed.
- Touch “” button once time, and the light will turn on. Repeat this action, the lights will turn off
- Power on, touch “” button for 3 seconds, and the auto heat cleaning function will be started. This function is heating for 9 minutes and the fan works fast for 1 minute.
- Touch “” button for 5 seconds in off mode. The gesture control function will be locked. Repeat this action, It will be turned on.

PART 5: MAINTENANCE

MODENA exhaust hood specifically designed for a long term use so that it does not require complicated maintenance. However, there are some things that are recommended to take care of your exhaust hood so that the quality is maintained. Turn the unit off and unplug the power cord from the electrical source before cleaning

Cleaning the Cabinet

To clean the surface of exhaust hood cabinet from sticky oil particles, use a cloth / sponge and soap water and then dry it out. The cabinet should be cleaned after each cooking session.

Cleaning the Filter

Smoke / steam from cooking and oil particles generated by the cooking process will immediately absorbed by the filter and therefore the filter should be cleaned regularly

1. Aluminum Filter:

- For routine usage, clean the aluminum filter once every 10 – 15 days by soaking the filter in a container filled with soap water for 1 hour (look at image) and use a soft brush to scrub it and then dry the filter thoroughly before placing it back to its proper position.
- Aluminum filter can be cleaned using a dishwasher.
- Avoid bending the filter when you wash it.

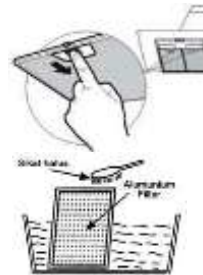

2. Carbon Filter :

Carbon filter must be replaced with a new one at least once every 4 months or when the carbon filter is no longer capable to absorb the cooking odor.

- Remove the aluminum filter first.
- Remove the carbon filter by pulling the hook (for square-shaped filter) or rotating it (for round – shaped filter).
- Install the new carbon filter.
- Reinstall the aluminum filter.

ATTENTION

Carbon filter cannot be washed and must be replaced with a new one in accordance with the description above

Cleaning oil container

Clean the oil cup when cleaning aluminum filter together a half of cup.

- Remove the oil cup by slide to left or right as the sl
- Wash using soap water, rinse and drying.
- Re-install the oil up on the exact position.

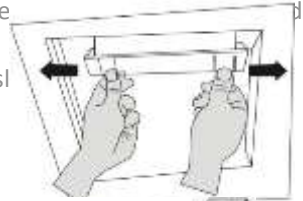

Changing the Light Bulb

1. Turn off the Hood and unplug the power cord.
2. Disconnect the wire and remove the lamp from exhaust hood body.
3. Change the bulb with the same size and power type.
4. Install the new lamp on the exhaust hood body and reconnect the wire

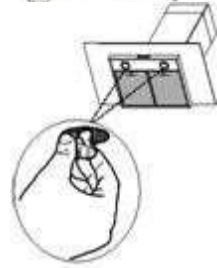

PART 6: PROBLEM & SOLUTION

Do check the things below before contacting our Service Center, if there is any interference with your exhaust hood:

Problem	Possible Cause	Recommended Action
The exhaust hood is not working	<ul style="list-style-type: none"> • The power cord is not yet connected to the electrical socket. • The electrical socket does not have any electricity 	<ul style="list-style-type: none"> • Connect the power cord to the electrical socket. • Connect the power cord to a properly functioning electrical socket
Deteriorating of Suction Power	<ul style="list-style-type: none"> • Dirty aluminum filter • Dirty carbon filter 	<ul style="list-style-type: none"> • Clean the aluminum filter, dry it, and place it back on the exhaust hood. • Replace the carbon filter with a new one.
The motor fan is not functioning	<ul style="list-style-type: none"> • Motor coil is broken 	<ul style="list-style-type: none"> • Contact MODENA Call Center
The motor stops working after a while	<ul style="list-style-type: none"> • Safety thermal regulator is active 	<ul style="list-style-type: none"> • The vent hood is installed too close to the stove. • Air circulation is not optimal. • Contact MODENA Service Center.

PART 7: PRECAUTION

- Make sure the hood is turned on after a while to allow the air around the cooking area to circulate properly and make sure the hood is turned off after this process.
- Periodically inspect the filter and oil reservoir. Make sure that the filter is in clean and good condition and make sure the oil reservoir is not exceeding the specified limit.
- If you smell burnt / burnt smell from the hood, immediately turn off the hood and contact the MODENA Service Center.
- Perform a routine service on your stove every 3 (three) months, because if there are problems / problems with your exhaust hood, it can be immediately identified and repaired. Contact MODENA Service Center
-

PART 8: SPECIFICATION

MODEL	CX 9753	CX 9330	CX 6330
Front panel's color	Diamond black	Stainless	Stainless
Number of Motor(s)	1 Turbo	1 Turbo	1 Turbo
Lamp(s)	2 LED	2 LED	2 LED
Exhaust speeds	3	3	3
Ionizer (Germinator)	Y	Yes	Yes
Filter's type	Cassette Aluminum + Carbon Filter + Vit.C Filter	Cassette Aluminum + Carbon Filter + Vit.C Filter	Cassette Aluminum + Carbon Filter + Vit.C Filter
Control	Touch Control	Push Button	Push Button
Voltage	220 – 240V / 50Hz	220 – 240V / 50Hz	220 – 240V / 50Hz
Motor Power	190 W	190 W	190 W
Lamp Power	2 x 2 W	2 x 2.5 W	2 x 2.5 W
Air circulation (m3/jam)	1000	900	900
Dimension (P x L x T) mm	895 x 470 x (770 – 1150)	900 x 500 x (580 - 1060)	600 x 500 x (580 - 1060)

MODEL	CX 9150	CX 6150	CX 7110 L
Cabinet's Material	Stainless	Stainless	Metal
Front panel's color	Stainless	Stainless	Black
Number of Motor(s)	1 Turbo	1 Turbo	1 Turbo
Lamps	2 LED	2 LED	2 LED
Exhaust speeds	3	3	3
Ionizer (Germinator)	Yes	Yes	No
Filter's type	Cassette Aluminum+ Carbon + Vit.C	Cassette Aluminum+ Carbon + Vit.C	Cassette Aluminum Filter + Carbon Filter
Control	Push Button	Push Button	Push Button
Voltage	220 – 240V / 50Hz	220 – 240V / 50Hz	220 – 240V / 50Hz
Motor Power	190 W	190 W	100 W
Lamp Power	2 x 2 W	2 x 2 W	2 x 2 W
Air circulation (m3/jam)	900	900	700
Dimension (P x L x T) mm	900 x 500 x (550 -1040)	600 x 500 x (580 -1060)	700 x 450 x (540– 1020)

MODEL	CX 7310 L	CX 9301	CX 9301
Cabinet's Color	Black	Stainless	Stainless
Front panel's color	Black	Black	Black
Number of Motor(s)	1 Turbo	1 Turbo	1 Turbo
Lamps	LED	LED	LED
Control	Push Button	Push Button	Push Button
Exhaust speeds	3	3	3
Filter's type	Cassette Aluminum Filter + Carbon Filter	Cassette aluminum filter, Carbon filter, Vit. + C filter.	Cassette aluminum filter, Carbon filter, Vit. + C filter.
Ionizer (Germinator)	No	Yes	Yes
Motor Power	100 Watt	210 Watt	210 Watt
Lamp Power	2 x 2 Watt	2 x 2 Watt	2 x 2 Watt
Voltage	220 – 240 V ; 50/60Hz	220 – 240 V ; 50/60Hz	220 – 240 V ; 50/60Hz
Dimension (P x L x T) mm	700 x 500 x (560–1045)	900 x 500 x (570 – 1050)	600 x 500 x (570 – 1050)

MODEL	CX 9777	CX 9177	CX 9157
Cabinet's Color	Stainless	Stainless	Stainless
Front panel's color	Black	Black	Black
Motor's Type	DC Motor	DC Motor	DC Motor
Lamps	LED	LED	LED
Control	Touch Control + Gesture Control	Touch Control + Gesture Control	Touch Control + Gesture Control
Exhaust speeds	Stepless Speed	Stepless Speed	3
Filter's type	Stainless Mesh Filter	Stainless Steel	Stainless Steel
Ionizer (Germinator)	No	No	No
Motor Power	268 Watt	230 Watt	200 Watt
Lamp Power	2 x 2 Watt	1x 4 Watt	1 x 4 Watt
Voltage	220V – 50Hz	220V – 50Hz	220V – 50Hz
Dimension (P x L x T) mm	895 x 425 x 660	895 x 515 x 655	895 x 520 x 600

MODEL	CX 7712 L	CX 9156	CX 9356
Cabinet's Color	Stainless	Stainless	Stainless
Front panel's color	Black	Stainless	Black
Number of Motor(s)	1 Turbo	1 Turbo	1 Turbo
Lamps	LED	2 LED	LED Stripe
Control	Push Button	Push Button	Touch Control
Exhaust speeds	3	3	4
Filter's type	Cassette Aluminum Filter + Carbon Filter + Filter Vit.C	Cassette Aluminum Filter + Carbon Filter + Filter Vit.C	Cassette Aluminum Filter + Carbon Filter + Filter Vit.C
Ionizer (Germinator)	Yes	Yes	Yes
Motor Power	210 W	190 W	300
Lamp Power	2 x 2 Watt	2 x 2.5 Watt	1 Z 8 Watt
Voltage	695x325x(680- 1070)	895x 600 x (650- 1250)	900x 500 x (570- 1050)

MODEL	CX 9701 L	CX 9754	CX 7754
Cabinet's Color	Black	Black	Black
Front panel's color	Black	Black	Black
Number of Motor(s)	1 Turbo	1	1
Lamps	LED	LED	LED
Control	Push Button	Touch Control + Gesture Control	Touch Control + Gesture Control
Exhaust speeds	3	3	3
Filter's type	Cassette Aluminum Filter + Carbon Filter	Cassette Aluminum Filter + Carbon Filter	Cassette Aluminum Filter + Carbon Filter
Ionizer (Germinator)	No	No	No
Motor Power	170 Watt	210 Watt	210 Watt
Lamp Power	2 x 2 Watt	2 X 1.5 Watt	2 X 1.5 Watt
Voltage	220 – 240 V ; 50/60Hz	220 – 240 V ; 50/60Hz	220 – 240 V ; 50/60Hz
Dimension (P x L x T) mm	900 x 340 x (800–1180)	900 x 360 x (740–1080)	700 x 360 x (740–1080)

MODEL	CX 7313 S	CX 9313 S	CX 9313 L
Cabinet's Color	Stainless Steel + Tempered Glass	Stainless Steel + Tempered Glass	Metal Painted + Tempered Glass
Front panel's color	Stainless	Stainless	Black
Number of Motor(s)	1	1	1
Lamps	LED	LED	LED
Control	Push Button	Push Button	Push Button
Exhaust speeds	3	3	3
Filter's type	Cassette Aluminum Filter + Carbon Filter Matt	Cassette Aluminum Filter + Carbon Filter Matt	Cassette Aluminum Filter + Carbon Filter Matt
Ionizer (Germinator)	No	No	No
Motor Power	220 Watt	220 Watt	220 Watt
Lamp Power	2 X 2 Watt	2 X 2 Watt	2 X 2 Watt
Voltage	220 – 240 V ; 50/60Hz	220 – 240 V ; 50/60Hz	220 – 240 V ; 50/60Hz
Dimension (P x L x T) mm	700 x 500 x 880	900 x 500 x 880	900 x 500 x 880

MODEL	CX 8917 LASS	CX 8717 LASS	CX 7915 GXBK
Cabinet's Color	Stainless	Stainless	Black
Front panel's color	Black	Black	Black
Motor's Type	AC Motor	AC Motor	AC Motor
Lamps	LED	LED	LED
Control	Touch Control + Gesture Control	Touch Control + Gesture Control	Touch Control
Exhaust speeds	3	3	3
Filter's type	Stainless Steel	Stainless Steel	Cassette Aluminum Filter + Carbon Filter
Ionizer (Germinator)	No	No	Yes
Motor Power	280 Watt	280 Watt	220 Watt
Lamp Power	2 x 2 Watt	1 x 2 Watt	2 x 1.5 Watt
Voltage	220V – 50Hz	220V – 50Hz	220V – 50Hz
Dimension (P x L x T) mm	895 x 370 x 998	710 x 356 x 835	900 x 430 x (360 – 1140)

MODEL	CX 7917 LABK	CX 7917 QAGY	CX 7917 QABK
Cabinet's Color	Black	Grey	Black
Front panel's color	Black	Grey	Black
Motor's Type	AC Motor	BLDC Motor	BLDC Motor
Lamps	LED	LED	LED
Control	Touch Control + Gesture Control	Touch Control + Gesture Control	Touch Control + Gesture Control
Exhaust speeds	3	3	3
Filter's type	Metal Mesh Filter	Metal Mesh Filter	Metal Mesh Filter
Ionizer (Germinator)	No	No	No
Motor Power	270 Watt	168 Watt	168 Watt
Lamp Power	1 x 6 Watt	1 x 4 Watt	1 x 4 Watt
Voltage	220V – 50Hz	220V – 50Hz	220V – 50Hz
Dimension (P x L x T) mm	895 x 382 x 573	902 x 460 x 977	902 x 460 x 977



PT MODENA INDONESIA

Jl. Industri Raya I Blok D-8,
Jatiuwung, Tangerang 15135