

User Manual Book Washing Machine

WW 1139 VSDG

TABLE OF CONTENT

Part 1: Safety Information	3
Precautions	3
Environmental Notice	5
Part 2: Name of Parts	5
Part 3: Installation Guide	6
Installation	6
Horizontal Adjustment	6
Dryer Installation	7
Tee Connector Installation	8
Drain Hose Installation	9
Inlet Hose Installation	10
Part 4: How to Use	13
Precautions Before Washing	13
Before First Wash	13
Washing Instruction	13
Control Panel	17
Display Panel	18
Using the Washer	23
Using the Dryer	23
Using the Smart Link	24
Opening Washer Door in Emergency	25
Opening Dryer Door in Emergency	25
Memory Function	26
ActiveWash Function	26
Abnormal Vibration Protection	26
Part 5: Maintenance	26
Cleaning & Maintenance	26
Detergent Drawer Cleaning	27
Drain Filter Cleaning	27
Drum Clean	28
Cleaning the Inlet Valve	28
Part 6: Troubleshooting	29
Part 7: Specification	31

This guide book explains everything you need to know about your new product. Please contact our Customer Care should you need further assistance through www.modena.com.

PART 1: SAFETY INFORMATION

Read the user manual book carefully!

- Do not try to install or turn on the unit without having read the indicated safety precautions in this manual.
- Do not disassemble the electrical parts of this appliance. Any repairs done by an unauthorized person may cause serious injuries or properties incident.
- The adult should supervise the children in order to make sure the children can not play with the appliance.
- The appliance is not intended for use by persons(including children) with reduced physical, sensory or mental capabilities, or lack of experience and knowledge, unless they have been given supervision or instruction concerning use of the appliance by a person responsible for their safety.
- This appliance is intended to be household use only. Usage outside the intended use or excessive use may void the warranty.
- Do not modify the power cord. If the power cord is damaged, it must be replaced by technician with a replacement cable according to the appliance specification
- To avoid danger of suffocation, keep plastic bag away from babies and children.

Precautions

- Destroy the carton, plastic bag and other packing materials after the appliance is unpacked. Children might use them for play.
- Children require supervision when using the appliance
- Plug the appliance directly into the socket and ensure secure connection
- The unit requires proper grounding and the correct voltage
- An appropriate length of power cord is provided to reduce the risks of becoming entangled in, or tripping over a longer cord.
- Do not use an extension cord or plug adaptor. Failure may cause electric shock or risk of fire
- Choose a place that is near a grounded electrical socket.
- Do not place the appliance sitting over the power cord.

- Do not pull out or insert the plug with wet hands to avoid electric shock.
- Do not fasten, twist or tie the power cord. If the power cord is damaged, it should be replaced by the manufacturer, service technician or a qualified person to prevent any risk.
- Do not spill water directly onto the control panel
- Fix the drain pipe before use, make sure that the drain hole is not blocked
- Keep the unit in a dry place and away from direct sunlight. Do not place the machine on paper or foam. Do not place anything flammable beside this machine.
- When washing at high temperature, the door glass will get hot. Please do not touch the door glass, especially children.
- When the door needs to be opened in high temperature washing, please wait until the temperature drops to the safe temperature and the door lock is automatically unlocked.
- Please close the door when the washing machine is not in use to prevent children from entering the washing barrel.
- Please do not wash waterproof clothes, such as raincoats, down products, sleeping bags, etc.
- Only machine washable clothes can be washed. If in doubt, please follow the washing guide on the clothes.
- Do not wash or dehydrate the clothes stained with kerosene, gasoline, diluent and other flammable materials.
- Unplug the unit when the unit will not be used for a long period for the reason of saving electricity.
- Never use organic liquids polishing chemical to clean the machine.

Environmental Notice

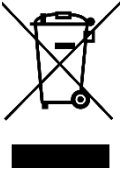

The packaging material used is recyclable. We recommend that you separate plastic, paper and cardboard and give them to recycling agents. According to WEEE (Waste of Electrical and Electronic Equipment) guidelines, waste from electrical and electronic devices should be collected separately. If you need to remove of this appliance in the future, do not throw it away with the rest of your domestic garbage. Instead, please take the appliance to the nearest WEEE collecting agents, where available.

PART 2: NAME OF PARTS

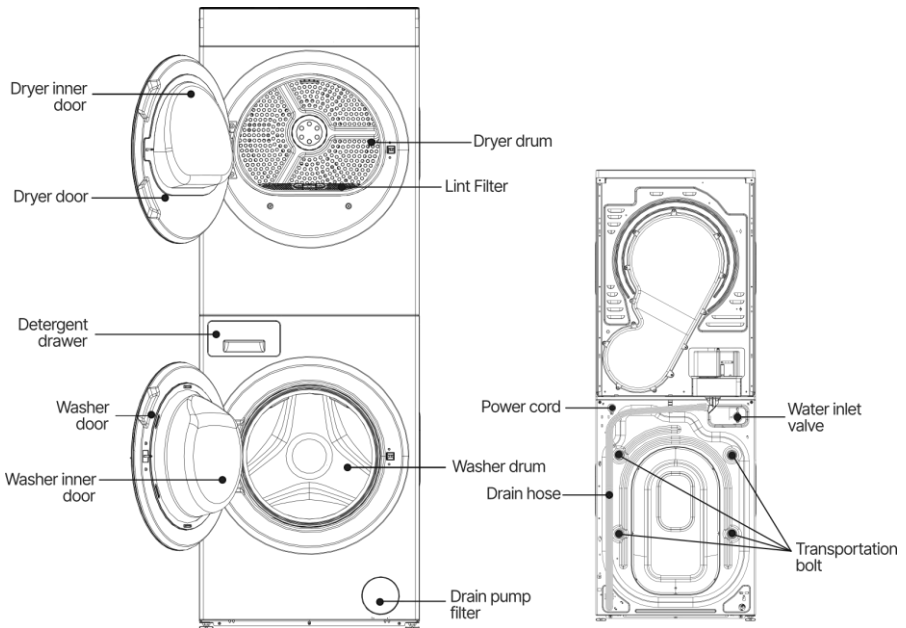

Above picture is for reference only. Actual product may have slight difference

PART 3: INSTALLATION GUIDE

Installation

- The appliance should not be installed in an environment below 0°C. Do not install or place the washing machine outdoors directly exposed to outside weather.
- Leave some space at least 10 cm between the appliance and the surrounding objects or wall
- Place the appliance on a sturdy flat surface
- Keep the appliance away from hot objects and water splashes.
- If there are many insects in the installation environment, please keep the surroundings of the washing machine clean. The warranty does not cover any damage caused by cockroaches or other insects.
- When installing the appliance, remove all packaging and the tub support base as shown in the picture. Failure to do so will hinder the appliance performance
- During first installation or first use, residual water may come out of the appliance. This is normal because the appliance was pre-tested in factory

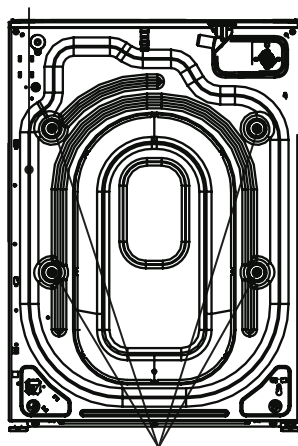

4 (pcs) transportation bolt

Horizontal Adjustment

- Adjust and level the appliance to prevent noise and vibration. Install on a sturdy flat surface (recommended place is on the corner of the room).
- If the surface is not flat, adjust the feet (do not insert foreign object such as a block of wood under the feet). Ensure that the appliance is level by using a leveling measurement device
- Adjust the feet until the appliance is level and lock the feet by tightening the nut

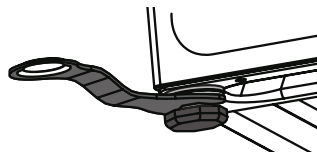

- Do not place the appliance on top of a desk to prevent the appliance from falling down
- Press the four top corners of the appliance, the appliance should not be able to wobble. If the appliance wobbles, readjust the feet
- The maximum recommended surface angle is no more than 2°.

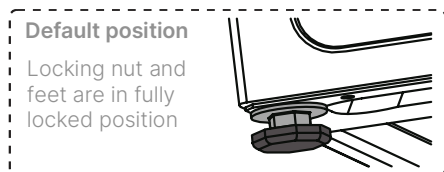
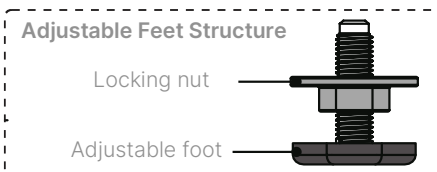
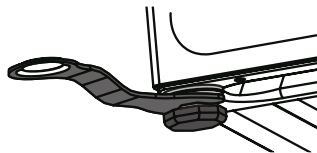

Dryer Installation

WARNING!

Installation of dryer should be performed by 2 (two) or more people.

1. Lift the dryer and place it on top of the washer unit. Make sure the four bottom corners of the dryer meet the four top corners of the washing machine.
2. Tilt the dryer unit so that the back touches the wall as shown in the picture and must be held by one person to prevent the dryer from falling.
3. Take the cord from the bottom of the dryer and the cord from the top of the washer. Connect the dryer and washing machine cable connectors.

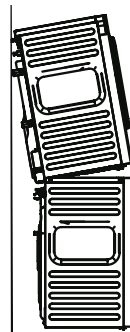

4. Take the junction box provided, then place the connected cables into the junction box.
5. Install the junction box in the hole provided at the top of the washing machine, with the arrow pointing out (see picture on the side).
6. The dryer has an emergency cord that opens the dryer door. Take the rope from the bottom right of the dryer, then insert it into the right bolt hole. Make a simple knot so the rope doesn't accidentally slip through the hole.
7. Install the 4 (four) ST4*16 bolts provided in each dryer installation hole.
8. Install the 4 (four) bolt hole cover stickers provided.

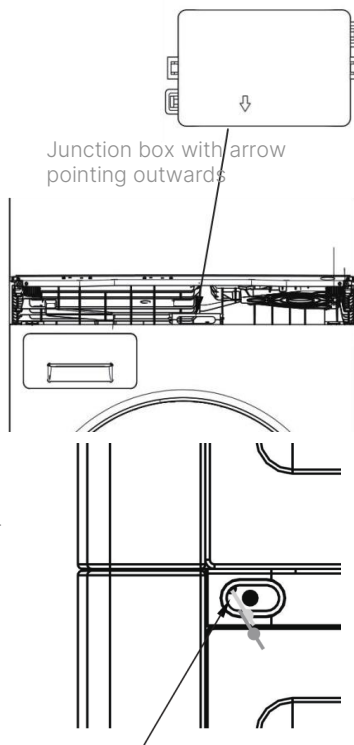

Dryer emergency cord

Tee Connector Installation

1. Remove the pump cover locking bolts as shown below, and remove the drain pump cover and support.
2. Take the tee connection and the 2 (two) ST4*16 bolts provided. Check tee connections for damage.



Tee connector



ST4*16 screw

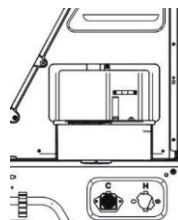

3. Install the tee connection on the container as shown in the picture (top view)

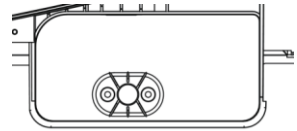

Drain Hose Installation

Before using the device, make sure the drain hose is properly installed

1. Attach the washing machine drain hose to the tee connection and install a circlip to seal the connection.
2. Attach the supplied drain hose to the tee connection and install a circlip to seal the connection. You can install the drain hose in the following 2 (two) ways:

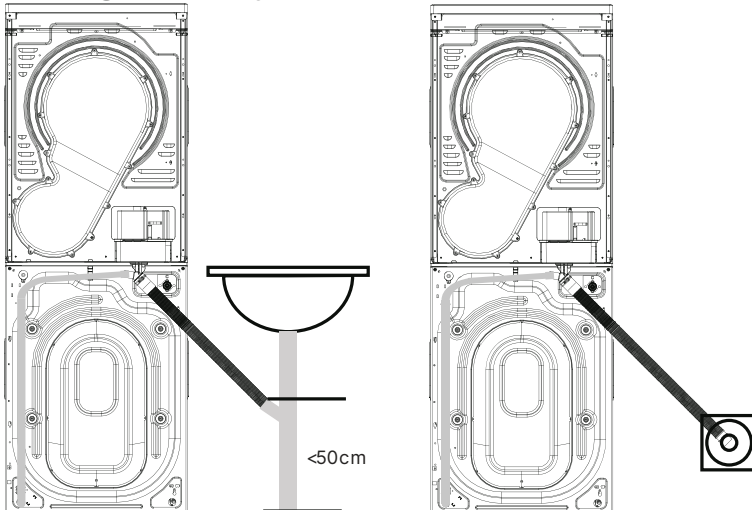

3. If the drain hose is too long, it can be cut as needed.

ATTENTION!

- Make sure the drain hose is not crushed or damaged by a heavy object falling on it. Otherwise, water drainage may be obstructed and there is a risk of leakage.
- If the drain hose is installed by a technician, do not move the position of the drain hose.
- Do not remove the circlip on the drain hose.
- Do not bend the drain hose excessively so that it forms a 'U' shape.
- If the drain hose is too long, do not force the hose into the drain hose. You can cut the excess length according to the picture above. If your drain hose is not long enough, contact after-sales service.

Inlet Hose Installation

Faucet Types

Types of faucet that can and can't be used are as follows:

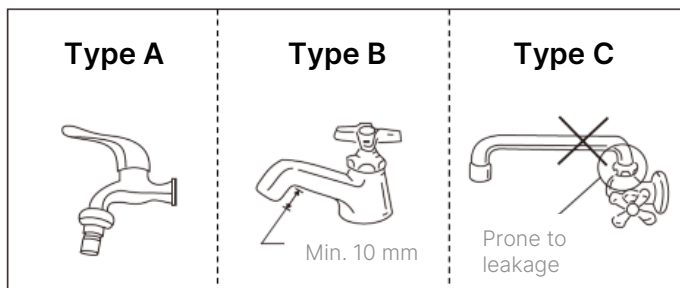

- Type A: This faucet is suitable for washing machine
- Type B: This faucet is suitable, however the front end should have minimum length 10 mm. The front end should be flat and smooth, otherwise it will cause leakage.
- Type C: This faucet is not suitable and may cause leakage



WARNING!

Use the inlet hose provided along with the appliance, your old inlet hose may not be used. If your faucet types are not suitable as above, replace the faucet first.

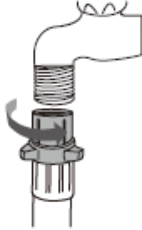
Water Faucet Connection

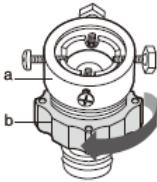
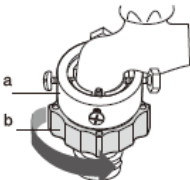
	<p>If your faucet has threads, the inlet hose can be installed directly by releasing the adapter and fit the connector the the faucet.</p>
	<p>If your faucet do not have threads, use the provided adapter. Release the adapter from the inlet hose.</p>
	<p>Use philips (+) screw to loosen the 4 (four) screws of adapter (a). Unscrew the locking nut (b) so as there is a 5 mm gap between the nut and adapter.</p>
	<p>Insert adapter (a) to faucet end and tighten the 4 (four) screws. Tighten the locking nut (b).</p>

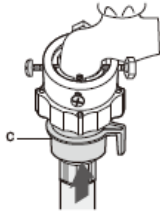

Install the inlet hose to the adapter by sliding and holding the part (c), insert the hose until you hear a click sound.

WARNING!

After installing the inlet hose, check for leakage. If there's a leakage, repeat above steps until there is no leakage left.

Installing Inlet Hose to the Washing Machine

Connect the other end of inlet hose to the inlet valve located on the back of the washing machine. Tighten the locking nut.

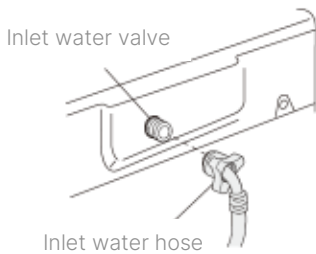

WARNING!

1. This washing machine is not designed for hot water source use. The inlet water temperature should be less than 30°C
2. The inlet water pressure should be between 0.05-0.8 MPa
3. Do not use the water inlet hose from another unit or an old unit

PART 4: HOW TO USE

Precautions Before Washing

1. Install the power plug to the main power socket
2. Make sure the inlet hose is installed properly and there is no leakage. Open the water faucet.
3. Make sure the drain hose is installed properly

Before First Wash

Before using your appliance for the first time, perform a tub cleaning procedure:

1. Press POWER button
2. Insert detergent directly into the drum
3. Open water faucet
4. Select DRUM CLEAN program
5. Press START/PAUSE button
6. Wait until the program is finished and after that the washing machine is ready to use.

Washing Instruction

Sorting Laundry

- Read Clothing Care Labels. In general, your clothes will have clothing care information labels. Check and read the care label to select the wash cycle and temperature. It is very important to follow the recommendations on the label to maintain the quality and lifespan of your clothing.
- Sort & Separate Clothes. To get maximum washing results and maintain the shape, color and overall quality of your clothes, sort and separate your clothes based on the following 5 (five) things:
 - Color. Separate colored clothes between white, light and dark. This will prevent the dye from mixing into your other clothes.
 - Fabric type. Different fabrics should be washed, mixed, and dried in different ways. Wool fabrics should not be washed the way cotton fabrics are washed.
 - Weight and size. Heavy and bulky fabrics such as towels and blankets should be washed separately. Small, delicate fabrics

- are placed in a laundry bag to avoid damage when they rub against each other.
- Stain. Clothes with specific heavy stains (mud, sauce, oil, etc.) should be washed separately from other clothes and may require pre-wash treatment.
- Clothes that use zippers should be washed separately to avoid damaging other clothes. Make sure the zipper is closed.
- Empty your laundry pocket and remove dirt and/or soil. Metal objects such as coins, safety pins, and belts in clothing can damage other laundry and the tub.
- Turn buttoned and embroidered clothing inside out.
- Clothes with long straps can get tangled up in other clothes. Make sure to tie the rope before washing.

Wash Net or Wash Separately

Use a laundry net or wash certain clothes separately

- Bras (which can be washed in water) should be put in the laundry net. Metal parts of the bra can penetrate and tear other laundry items.
- Cashmilon and other bulky, lightweight clothing (lace garments, underwear, nylon stockings, synthetic fibers) can float and cause damage to clothing and engine problems. Use a laundry net or wash separately.
- Do not wash laundry nets without contents. Doing so may cause abnormal vibrations that could shift the washing machine and result in injury.

Pre-Treatment (if needed)

For maximum washing results, clean heavily soiled stains before putting them in the washing machine.

- To clean stains and dirt on collars, sleeves, pleats and pockets, pour a small amount of detergent and brush.
- Use powder or liquid detergent. Do not use soap, as it may remain in the drum after washing.
- First wash the white socks, sleeves and collar with a little detergent, then brush.

ATTENTION!

Make sure the laundry is loaded completely. Laying parts of the laundry can result in damage to the machine or the laundry itself, or water leaks. Make sure the laundry does not exceed the plastic mouth of the washing drum

Determining Laundry Capacity

Your washing machine is equipped with modern sensor technology that can read the laundry load and adjust time, water and energy automatically for optimal results. The washing capacity of your washing machine is designed based on the type of cotton fabric in dry condition. The washing capacity of other types of fabric may vary. As a practical guide, you can load your washing machine as follows:

- Small load: $\frac{1}{4}$ of the drum
- Medium load: $\frac{1}{2}$ of the drum
- Large load: $\frac{3}{4}$ of the drum

Don't put too many clothes in the washing machine drum. Washing machines need space for items to move, and for water to circulate effectively.

Selection and Use of Detergent

The type of detergent depends on the type of fabric (cotton, synthetics, delicate items, wool), color, washing temperature and degree of soiling. Always use a "low suds" laundry detergent, designed for automatic washing machines.

- Use enough detergent. Excessive amounts of detergent do not improve washing results, but result in damage to the laundry due to reduced rinsing performance.
- Bleach is a strong alkali, which causes damage or discoloration to laundry.
- Use an increased or longer rinse cycle when using powdered detergent that is likely to remain in the laundry and cause an unpleasant odor after the wash is complete.
- If excessive amounts of detergent are used, especially in cold water, the detergent will not dissolve completely, leading to contamination of the wash, hose, and/or tub.

WARNING!

Do not use detergents that tend to harden or solidify. Detergent like this will remain after the rinsing process, blocking the drain hole.

Always use detergent according to the detergent manufacturer's instructions printed on the packaging. See the table below for each water level option and adjust your detergent usage accordingly.

Using the Detergent

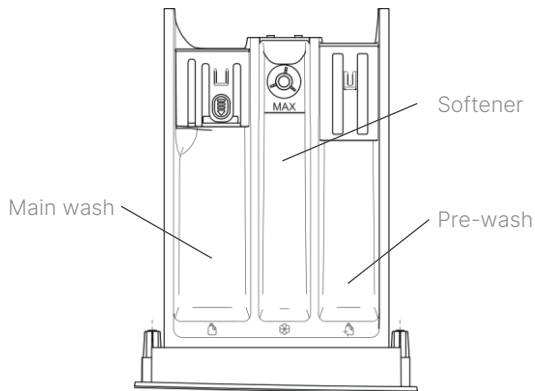

The detergent box is divided into 3 parts as shown in the picture.

- If you need pre-wash, put detergent in the Pre-wash section. 🧴
- Put detergent into the Main Wash section 🧴
- Put clothes softener into the softener section 🧴

The symbols printed on the detergent box may be different, but the division and function remain the same

Control Panel

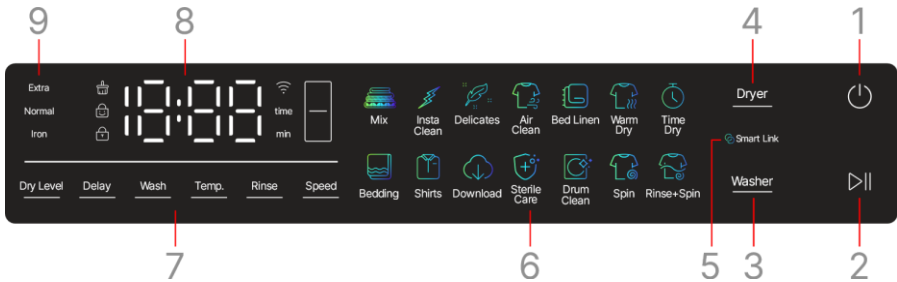

Note: The control panel image is for reference only, actual product may have differences

1	<p>Power</p> <p>Press the Power button for 3 seconds to turn on and/or turn off the machine. If there is no button operation in the on condition within 10 minutes, the machine will automatically turn off.</p>
2	<p>Start/Pause</p> <p>In standby condition, press this button to start or pause the program. When in standby or suspend mode, the “.” mark on the display will light up. When the program is running, the “.” sign will flash.</p> <p>If you want to load the remaining laundry into the washing machine, while the machine is running, press the Washer button and press and hold the Start/Pause button for 3 seconds. The machine will detect the temperature and water level. If it is at a safe temperature and level, the door can be opened and you can load the laundry into the washing machine.</p> <p>If you want to put the remaining laundry into the dryer, press the Dryer button and press the Start/Pause button. The door can be opened and you can load the laundry into the dryer.</p>
3	<p>Washer</p> <p>In standby state, press this button to enter washing mode. The panel will display programs and personalization for washing.</p>
4	<p>Dryer</p> <p>In standby state, press this button to enter drying mode. The panel will display programs and personalization for drying.</p>
5	<p>Smart Link</p> <p>In standby condition, press the Washer button, then press the program button that supports Smart Link, then press the Smart Link button.</p>
6	<p>Program</p> <p>Program display is available in Washer and Dryer mode. When a program is selected, the icon will flash and other program icons will light normally. A list of programs can be seen in the next table.</p>

7	Personalization (extra function) When one of the function buttons is selected, its parameters will be visible on the display. Additional functions vary depending on the mode selected. Additional function parameters vary depending on the selected program. A list of personalizations can be seen in the next table.
8	Parameter Display Washing and drying parameters will be displayed, such as program time, active mode, indicators, dryness level, etc.)

Display Panel

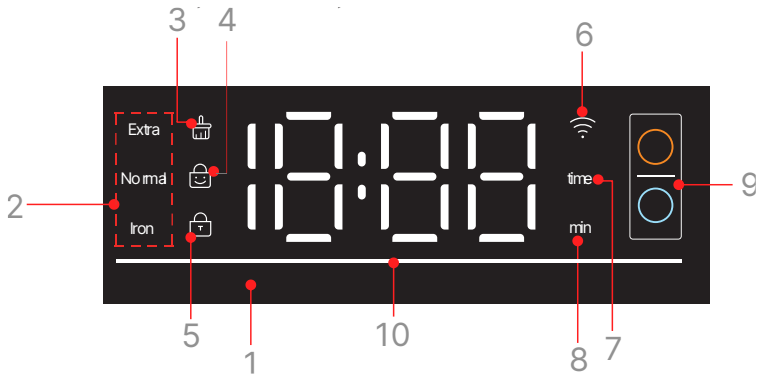

1	Display area Displays time, alarm information, additional function parameters
2	Dry Level Displays dryness level options
3	Lint Filter Cleaning Prompt When the drying program is complete, this icon will flash for 10 seconds to remind you to clean the lint filter behind the dryer door.
4	Child Lock When this icon is lit, the control panel is locked out of settings
5	Door Lock When this icon is lit, the door is locked
6	Wi-Fi If connectivity is successful and active, this icon will remain lit
7	Rinse times In Washer mode, if this icon is lit, then the number of rinse options can be set
8	Time When the machine is operating, if this icon is lit, then the program time options can be set
9	Mode The circle will light up according to the currently active mode. In Dryer mode, the top circle will light up. In Washer mode, the bottom circle will light up

10	<p>Progress Bar</p> <p>If this indicator lights up silently, then the machine is in standby state. If this indicator is flashing, the machine is operating</p>
----	---

Note: The display area configuration may differ from the actual item

Washer Programs

Program	Description	Temperatur selection (°C)	Spin speed selection (rpm)	Recommended load (kg)
Mix <i>(Smart Link)</i>	Cotton, Linen, Synthetic, or a mixture of all three	--/20/30/40	800/1000/1200	11 (cotton) 6 (mix)
InstaClean <i>(Smart Link)</i>	Clothes are not too dirty, light clothes	--/20/30/40	400/800/1000	2
Delicates <i>(Smart Link)</i>	Lace, wool, silk clothes	--/20/30/40	400/600/800	2
Bedding <i>(Smart Link)</i>	Bed sheets, blankets, large cloths	-- /20/30/40/60	400/600/800/ 1000/1200	6
Shirts <i>(Smart Link)</i>	Shirts, light clothing	--/20/30/40	400/600/800/ 1000/1200	2
Download <i>(Smart Link)</i>	See the 'Download' table	See the 'Download' table	See the 'Download' table	See the 'Download' table
SterileCare <i>(Smart Link)</i>	Clothes that require sterilization from viruses, bacteria, mites and can be washed at high temperatures	95	800/1000/1200	2
Drum Clean*	-	60	800/1000/1200	-
Spin	All clothes, only spin	-	800/1000/1200	11
Rinse+Spin	All clothes, rinsing and wringing	-	800/1000/1200	11

**)Do not load any clothing while using the Drum Clean program as this may damage your clothing!*

Washer Download Programs

Program	Description	Temperature selection (°C)	Spin speed selection (rpm)	Recommended load (kg)
InstaClean 30*	The clothes are not too dirty, the clothes are medium	30	400/800/1000/1200	2
HygieneCare	Clothes that can be washed at high temperatures	60/90	800/1000/1200	2
ColorCare	New clothes or colored clothes	--/20/30/40	400/600/800/1000/1200	5
Hand Wash	Clothes that tangle easily	--/20/30/40	400/600/800	5
AllergyCare	Children's clothing	--/20/30/40/60	600/800/1000/1200	5

*)Default program

NOTE

The Download program is only available on models with Wi-Fi connectivity. On models that are not connected, the program that applies is the default program.

Dryer Programs

Program	Description	Dry Level selection	Recommended load (kg)
Mix (Smart Link)	Cotton, Linen, Synthetic, or a mixture of all three	Iron/Normal/Extra	11
InstaClean (Smart Link)	Light clothing	Iron/Normal/Extra	2
Delicates (Smart Link)	Lace, wool, silk clothes	Iron/Normal/Extra	3
Bedding (Smart Link)	Bed sheets, blankets, large cloths	Iron/Normal/Extra	6
Shirts (Smart Link)	Shirts, light clothing	Iron/Normal/Extra	3

Program	Description	Dry Level selection	Recommended load (kg)
SterileCare (Smart Link)	Clothing that requires sterilization	Extra	2
Download (Smart Link)	See the 'Download' table	See the 'Download' table	See the 'Download' table
AirClean	Shirts, suits, light jackets	Normal	3
Bed Linen	Blankets, bed sheets, large and thick cloths	Iron/Normal/Extra	3
Warm Dry	Clothes that are not too wet or to remove light creases	Normal	3
Time Dry	Drying over a certain period of time	Normal	4

Dryer Download Programs

Program	Description	Dry Level selection	Recommended load (kg)
AllergyCare*	Children's clothing	Iron/Normal/Extra	6
Wool	Only for Wool	Iron/Normal/Extra	2
Silk	Only for Silk	Iron/Normal/Extra	2

**)Default program*

NOTE

The Download program is only available on models with Wi-Fi connectivity. On models that are not connected, the program that applies is the default program.

ATTENTION!

- When drying wool or silk clothing, first read the Care Instructions Label on your clothing.
- Some programs have an Adaptive Wash feature, namely a laundry load sensor. When the indicator on the display flashes and the time display stops, the program time will be displayed again after the load has finished weighing approximately 2-3 minutes.
- Your device is equipped with vibration protection. The machine will rotate the drum several times during the washing process so the actual washing time may be longer. This is normal.
- During the drying process, the machine will detect the dryness level automatically and adjust the drying time according to the sensor reading. The time remaining on the display may change. This is normal.
- Don't put too many clothes in the dryer. Clothes will expand due to drying at higher temperatures. Clothing with zippers, buttons, or other attached objects can rub excessively against the drum and glass, causing damage.

Personalization (extra function)

Function	Description
Dry Level	Select the desired dryness level. <ul style="list-style-type: none">• Iron: Sufficient dry level for later ironing• Normal: Normal dry level• Extra: Extra dry level, clothes can be folded directly
Delay	Delay the completion of the program. If activated, the program will finish several hours after you press the Start button. The delay time can be selected from 3-24 hours
Wash	Select the washing or drying time option. Time options depend on the program selected
Temp.	Select the washing temperature option. Temperature options depend on the selected program. (-/20/30/40/60)
Rinse	Select the flushing option. Rinsing options can be selected from 2/3/4/5 times
Speed	Select the spin speed option. Speed options depend on the selected program. (400/600/800/1000/1200)

Function	Description
Child Lock	While the program is in progress, you can lock the control panel so that the settings cannot be played with by children. To turn the Child Lock function on or off, press and hold the 'Delay+Wash' buttons simultaneously for 3 seconds. All buttons except the Power and Child Lock buttons will be locked. Once the program is complete, the Child Lock function will automatically turn off.

Using the Washer

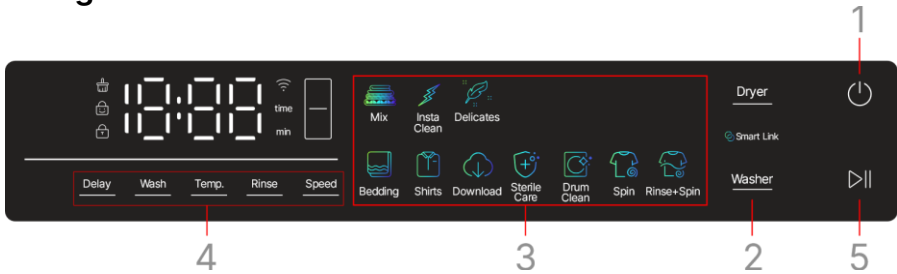

1. Press the 'Power' button
2. Press the 'Washer' button
3. Select the desired washing program
4. Select the desired personalization or advanced settings
5. Press the Start/Pause button

Using the Dryer



1. Press the 'Power' button
2. Press the 'Dryer' button
3. Select the desired drying program
4. Select the desired personalization or advanced settings
5. Press the Start/Pause button

NOTE

1. In 'Smart Link' mode, after the washing process is complete, open the washing machine door and transfer the laundry to the dryer. Close all machine doors then press the Start/Pause button.
2. When washing with 'Smart Link' mode is active, if you select a program on the Dryer, the 'Smart Link' mode will automatically be deactivated and replaced with a new program.

Opening Washer Door in Emergency

In an emergency situation such as a power failure, you can open the washing machine door manually.

1. Check that the water level is safe and that the water temperature is approximately below 40°C
2. When the drum is not rotating, disconnect the water drain hose and lower it in a flat position on the floor, water will come out of the hose. Wait until no remaining water comes out, then return the hose to the top position
3. Open the pump filter cover on the lower right front of the machine. You can pull the emergency lever down with a straight screwdriver until you hear a sound
4. Open the door and remove the clothes from the washing machine
5. Close the pump filter cover again

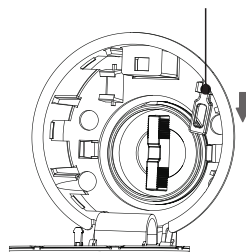

Opening Dryer Door in Emergency

In an emergency situation such as a power failure, you can open the washing machine door manually.

1. Open the long bolt hole cover on the right side of the machine
2. Grab and pull the emergency rope until you hear a sound
3. Open the door and remove the clothes from the dryer

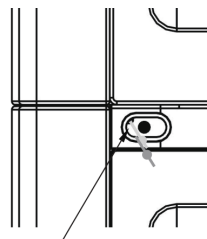

4. Return the strap to the hole and close the bolt hole again

Memory Function

Your machine is equipped with a memory feature that can store the last conditions before the power cut occurred. When the power comes back on, the machine will continue the final washing or drying process.

ActiveWash Function

At the start of the program, the machine will detect the load of laundry in the drum. After the detection process, the machine will adjust the amount of water and washing time for maximum and effective results.

Abnormal Vibration Protection

- Your machine can detect abnormal vibrations that occur when the load on the drum is uneven. The machine will rotate and redistribute the clothes in the drum until the load is evenly distributed
- If the clothes cannot be distributed evenly within a certain time, the machine will continue to rotate at a low speed so as not to cause excessive vibration and noise
- If there are too few clothes in the drum, the machine may not spin. You can add clothes to the drum to overcome this

The machine will rotate the drum several times during the washing process so the actual washing time may be longer. This is normal.

PART 5: MAINTENANCE

Cleaning & Maintenance

1. Periodic cleaning & maintenance can prolong the life time of your appliance
2. Ensure the power cord is unplugged before performing cleaning and maintenance activity
3. Please wipe the body with a soft and clean cloth every time after the washing machine is used. When there are serious stains, please wipe the body with a cloth dipped in appropriate detergents or soapy water.
4. Do not spray water on the body directly

5. Do not wipe the body with chemicals such as putty-powder, diluting agents, gasoline and alcohol
6. Clean the Door Seal. Please wipe stains and foreign matters such as thread chips away with a towel every time after using. If there are foreign matters such as pins in the groove of the door seal, please take them out.

Detergent Drawer Cleaning

If there is detergent left in the detergent box, you can remove the detergent box by gently pulling the box out. When the box can no longer be pulled out, press and hold the plastic lock as shown in the picture, then pull the box out. Wash the detergent box with water until clean. Return the detergent box to its original place by inserting and pushing the detergent box inward.

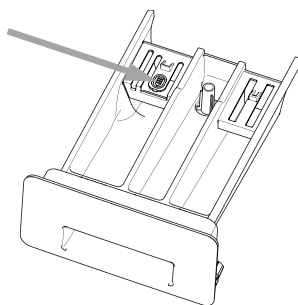

After the washing process, a small amount of detergent and fragrance may remain in the box and this is normal. When the machine is operating, do not open the detergent box to avoid water splashing.

Drain Filter Cleaning

It is recommended to clean the pump filter twice a year.

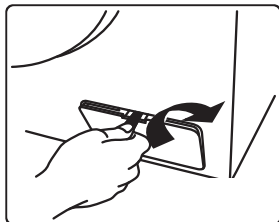

Press the pump cap with your hand until it opens

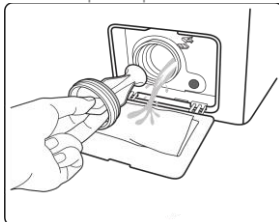

Open the filter by turning counterclockwise (be careful if there is remaining water). Clean with water and remove remaining clothing fibers.

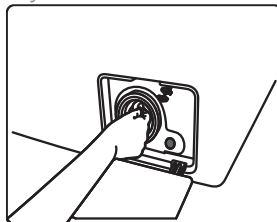

Place it back into the washing machine by turning clockwise. Do not operate the machine without a filter!

Drum Clean

It is recommended to wash the drum periodically so that the washing drum is always kept clean. Use the DRUM CLEAN program to wash the drum at least once a month.

ATTENTION!

To protect the drum from excess moisture and the potential growth of mold and mildew, open the washing machine door after each wash to allow the drum to dry and prevent unpleasant odors.

Cleaning the Inlet Valve

1. Remove the water inlet hose from the washing machine
2. Remove the filter from the inlet valve
3. Clean the filter with a toothbrush or suitable tool
4. Reattach to intake valve
5. Connect the water inlet hose
6. It is recommended to do this every 6 months.



Inlet water valve

PART 6: TROUBLESHOOTING

Before contacting service center, check the following table:

Problem	Possible Cause	Recommended Action
Appliance is not working	<ul style="list-style-type: none"> • Power plug is plugged incorrectly • Switch is in OFF condition 	<ul style="list-style-type: none"> • Ensure the appliance is properly plugged into the power socket and the switch is turned ON.
Poor Spinning and abnormal noise	<ul style="list-style-type: none"> • Transportation bolt still attached • Incorrect installation • Overloading/overfilling the drum • Incorrect adjustment of feet 	<ul style="list-style-type: none"> • Remove the transportation bolt • Install on a hard and level surface • Load the drum according to the recommended capacity • Adjust and lock the adjustable feet
Too much foam	<ul style="list-style-type: none"> • Improper use of detergent 	<ul style="list-style-type: none"> • Use low foam detergent for washing machine
Door cannot be opened	<ul style="list-style-type: none"> • Program is running 	<ul style="list-style-type: none"> • Wait until the program is finished
E1 – Water supply failure	<ul style="list-style-type: none"> • The tap is closed • Clogged hose/filter • Water pressure too low 	<ul style="list-style-type: none"> • Make sure the tap is open • Check and clean the hose/filter • Check your home's water pressure
E2 – Drain failure	<ul style="list-style-type: none"> • Drain hose too high • The drain hose is clogged 	<ul style="list-style-type: none"> • Install the drain hose as recommended • Unclog the drain hose
E3 – Washing machine door lock failure	<ul style="list-style-type: none"> • The door is not closed tightly • Damage to door lock 	<ul style="list-style-type: none"> • Check and close the washing machine door tightly

Problem	Possible Cause	Recommended Action
E4 – Overflow alarm	<ul style="list-style-type: none"> • Water inlet valve failure • Water sensor malfunction • Exhaust motor failure 	<ul style="list-style-type: none"> • Contact after-sales service
E5 – Washer motor failure	<ul style="list-style-type: none"> • Motor damage 	<ul style="list-style-type: none"> • Contact after-sales service
E6 – Heater failure	<ul style="list-style-type: none"> • Heater damage 	<ul style="list-style-type: none"> • Contact after-sales service
E7 – Heater sensor failure	<ul style="list-style-type: none"> • Sensor damage 	<ul style="list-style-type: none"> • Contact after-sales service
E9 – PCB communication failure	<ul style="list-style-type: none"> • Wiring damage 	<ul style="list-style-type: none"> • Contact after-sales service
nSP – Spin failure during start, unit stops and alarm sounds	<ul style="list-style-type: none"> • Drum underloaded • Drum overloaded 	<ul style="list-style-type: none"> • Add load • Reduce load
 light indicator flashes	<ul style="list-style-type: none"> • Dirty/clogged lint filter 	<ul style="list-style-type: none"> • Clean lint filter
E3-4 – Dryer door lock failure	<ul style="list-style-type: none"> • Pintu tidak tertutup rapat 	<ul style="list-style-type: none"> • Close the door tightly
E4-2 – Overflow alarm in dryer	<ul style="list-style-type: none"> • Drain hose clogged 	<ul style="list-style-type: none"> • Check and unclog drain hose • Contact after-sales service
E41 – Compressor temperature sensor failure	<ul style="list-style-type: none"> • Electrical connection issue • Sensor failure 	<ul style="list-style-type: none"> • Contact after-sales service
E42 – Air duct temperature sensor failure	<ul style="list-style-type: none"> • Electrical connection issue • Sensor failure 	<ul style="list-style-type: none"> • Contact after-sales service
E71 – Display PCB communication failure	<ul style="list-style-type: none"> • Electrical connection issue 	<ul style="list-style-type: none"> • Contact after-sales service

PART 7: SPECIFICATION

Model	WW 1139 VSDG
Type	WashStation
Washer motor	PowerHub™ Inverter
Drying system	Heat Pump
Wash capacity (kg)	11.0
Dry capacity (kg)	11.0
Max. spin speed (rpm)	1200
Washer programs	10
Dryer programs	11
Inlet water pressure (MPa)	0.05-0.80
Washer power input (Watt)	1850
Dryer power input (Watt)	600
Rated voltage & frequency	220V~50Hz
Refrigerant	R134a (225 g)
Product dimension (W×D×H)(mm)	595×628×1680
Product weight (kg)	107

**WH = White; GY = Grey; SR = Silver, DG = Dark Grey

Design and specification can change without prior notice to improve the quality of the product. The illustration in this manual is schematic and can be different with your actual product. The values on label or in other documents are according to laboratory test and relevant standards. Values can vary depending on the actual operational and environmental condition of the product.

APPENDIX: CIRCUIT DIAGRAM

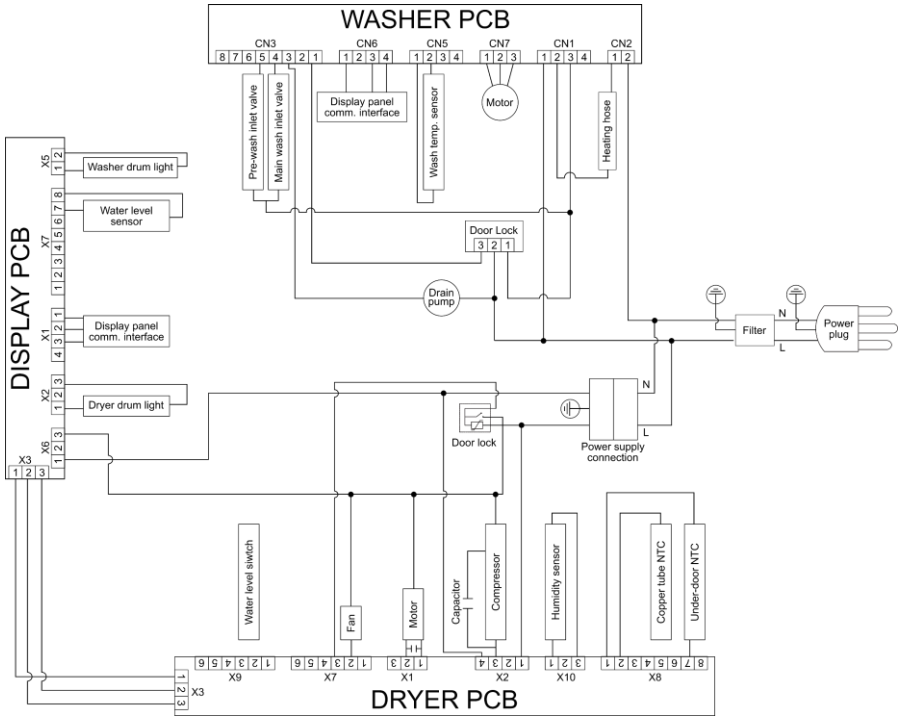

Ciao! **MODENA**

www.modena.com

PT MODENA INDONESIA

Jl. Industri Raya I Blok D-8,
Jatiuwung, Tangerang 15135