

User

Manual Book

Water Purifier

Igienico Series

RO 9115, RO 8115, RO 8101

MODENA

Thank you for your trust in choosing MODENA products for your household needs. With your satisfaction as our priority, we constantly aim to deliver stylishly designed products equipped with state-of-the-art technology to assist you in your daily activities.

This is your guidebook containing everything you need to know about our product. Please reach out to us if you need further assistance or other information via our Customer Care or our official website www.modena.com.

MODENA

CONTENTS	PAGE
● Introduction	2
● Part 1 : Name of Parts	4
● Part 2 : Installation	7
● Part 3 : How to Use	11
● Part 4 : Maintenance	13
● Part 5 : Precaution Action	14
● Part 6 : Problem & Solution	16
● Part 7 : Specification	17

Part 1: Name of Parts

RO 9115

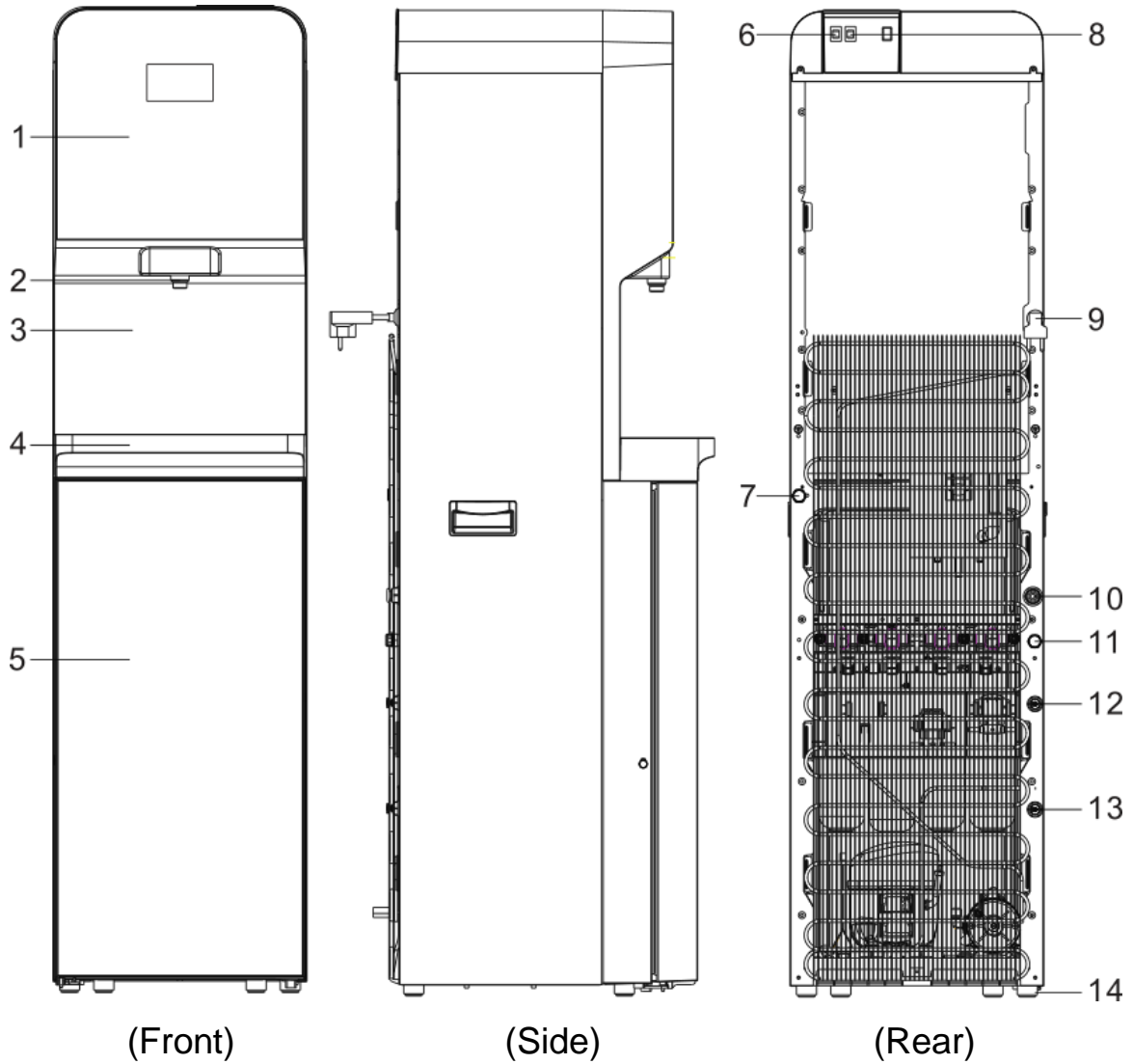

Remarks:

- | | | |
|--------------------|------------------------------|-----------------|
| 1. Control Panel | 7. Cold water drain | 13. Water inlet |
| 2. Water tap | 8. Cooling switch | 14. Base |
| 3. Body of product | 9. Power Cord | |
| 4. Water collector | 10. Water tank drain | |
| 5. Door | 11. Hot water drain | |
| 6. Heating switch | 12. Concentrated water drain | |

RO 8115

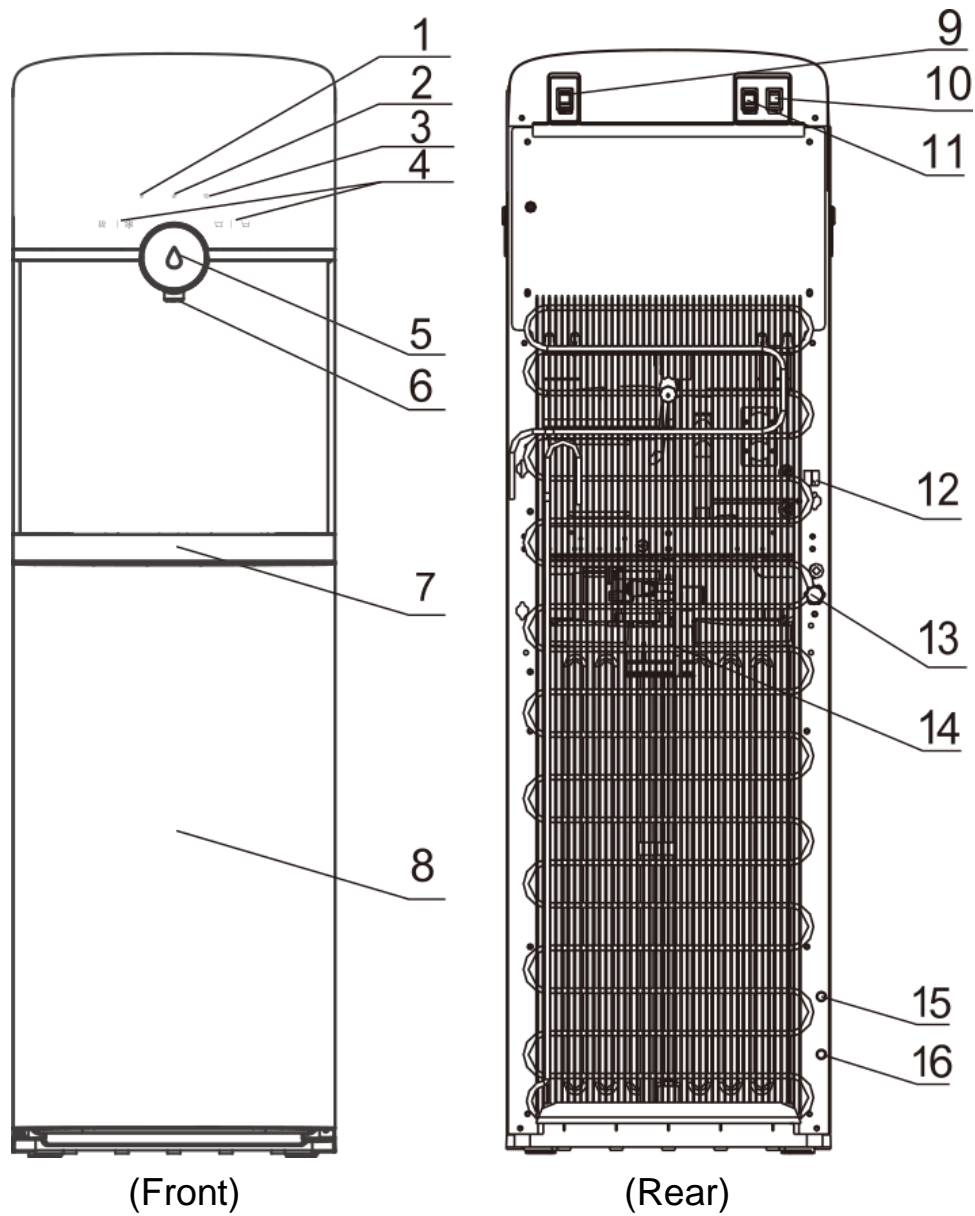

Remarks:

- | | | |
|-----------------------|------------------------|---------------------|
| 1. Heating lamp | 7. Water collector | 13. Hot water drain |
| 2. Cooling lamp | 8. Door | 14. Condenser |
| 3. Filter change lamp | 9. Filter reset switch | 15. Water drain |
| 4. Control Panel | 10. Heating switch | 16. Water inlet |
| 5. Water button | 11. Cooling switch | |
| 6. Water tap | 12. Power cord | |

RO 8101

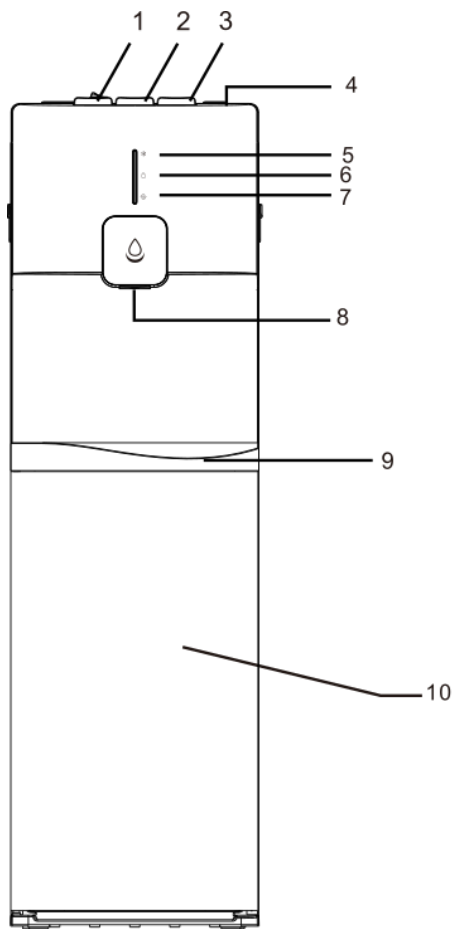

(Front)

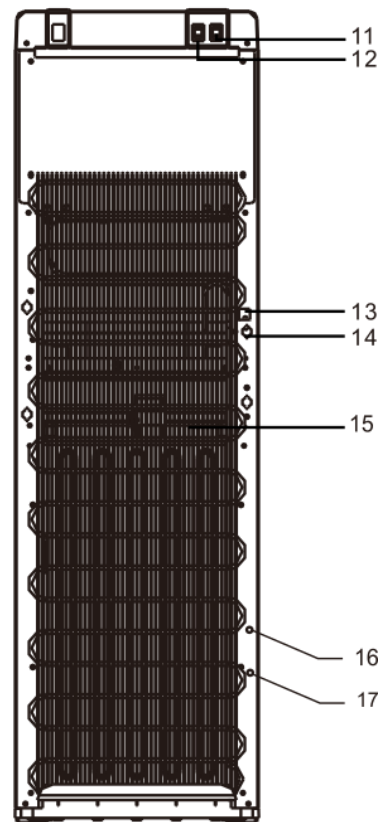

(Rear)

Remarks:

- | | | |
|----------------------|-----------------------|-----------------|
| 1. Hot water button | 7. Filter change lamp | 13. Power cord |
| 2. Not available | 8. Water tap | 14. Water drain |
| 3. Cold water button | 9. Water collector | 15. Condenser |
| 4. Top cover | 10. Door | 16. Water drain |
| 5. Heating lamp | 11. Heating switch | 17. Water inlet |
| 6. Cooling lamp | 12. Cooling switch | |

Part 2: Installation

Please read this instruction manual carefully before operating the unit to ensure safety and proper usage. Pay attention to the entire sign in either pictures or written explanation.

1. Open the top of the cardboard, take out the foam and accessories. Unpack the product and install the water collector
2. Place the product on a flat and stable surface. Provide a minimum of 25 cm distance on each side from the wall.
3. Leave the product for 1 hour to stabilize the refrigerant in the cooling system
4. Take out the quick joint and connector and install it on the water pipe

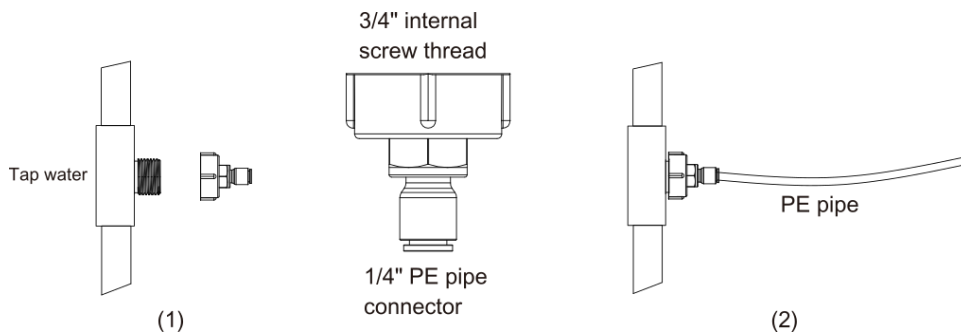

5. Use the accessory (filter flushing tip) to clean the filter. Insert the PE pipe to the quick joint. The arrows represent the water flow direction.

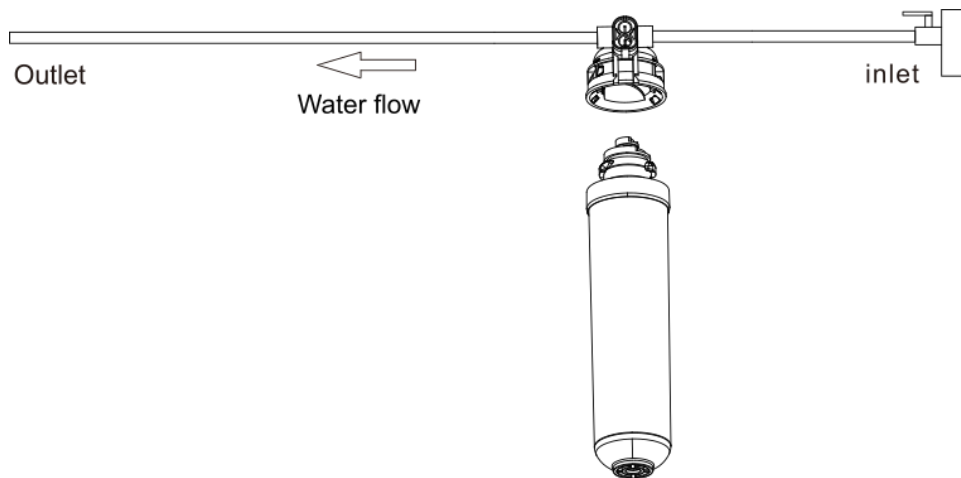

6. Insert Filter#2 C1 (active carbon) to the filter housing, tighten it by turning it counterclockwise and open the water tap to flush the filter until it doesn't discharge black water for about 10 minutes. Take the same step to flush Filter#4 C4 (active carbon).

7. Install all filters into the product. Hold the filter in your left hand and filter housing in your right hand, insert it upwards and tighten it by turning it counterclockwise. The filter installation order is:

Filter#1 PP → Filter#2 C1 → Filter#3 RO → Filter#4 C2

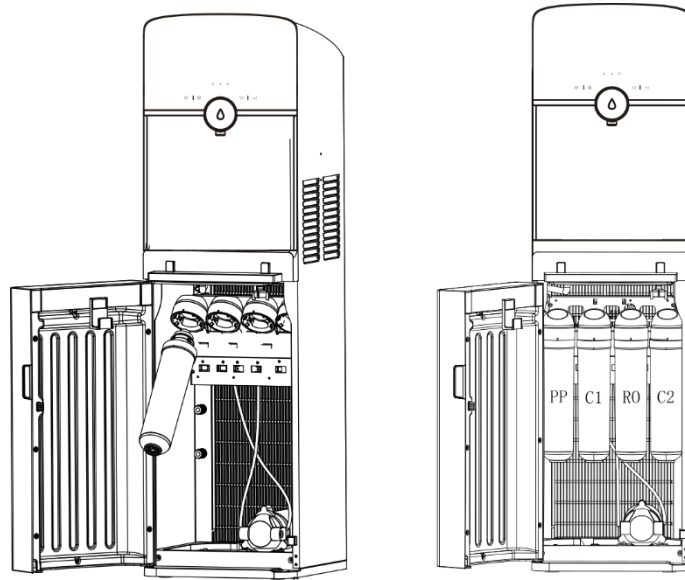

8. Take out the pin of the quick joint at the rear of the product, and then take out the white plug (see picture below)

RO 9115

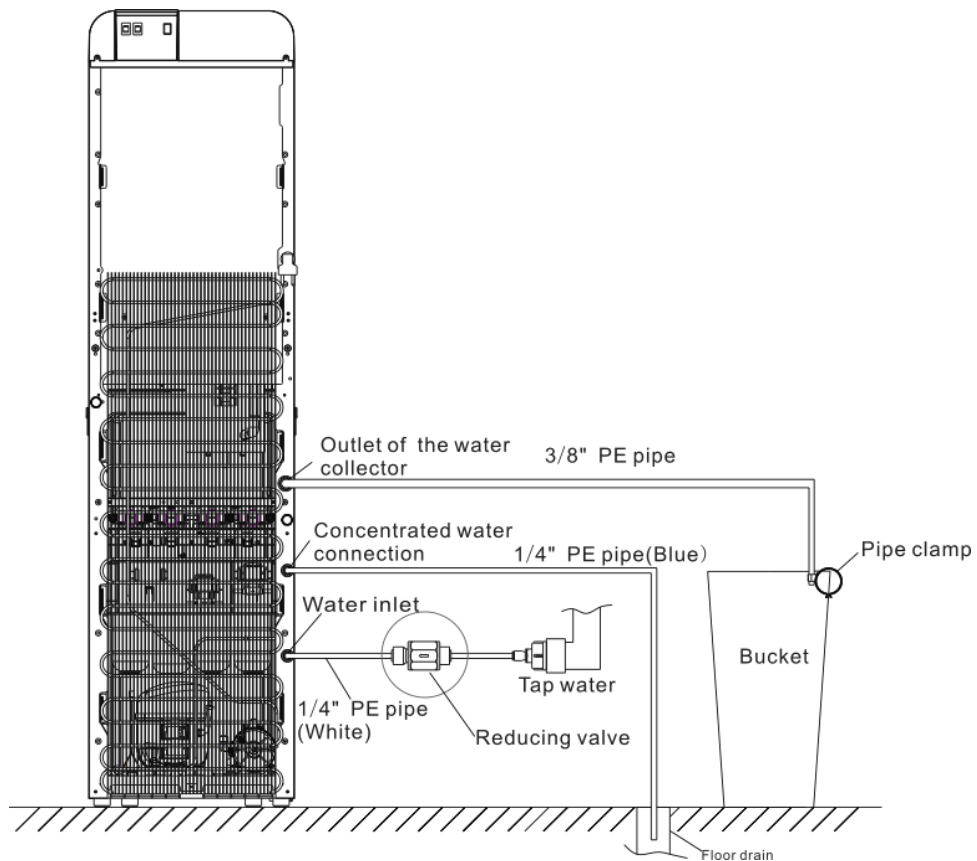

RO 8115 & RO 8101

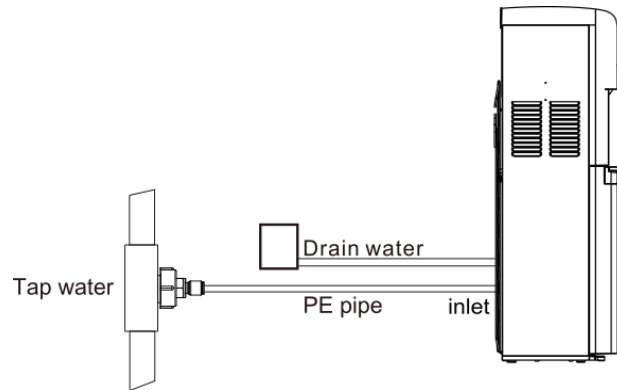

9. Insert the PE to the pipe water inlet quick joint and tighten it.
10. When installing or replacing the filters, make sure that the product is turned off and disconnected from power source.
11. Plug the cable to power socket. Ensure that the plug is properly grounded to prevent electrical failure. Turn on the heating and cooling switch located at the back of the product.
12. After everything is installed, wait for 2 hours for cooling and 15 minutes for heating of water before consuming.

To prevent the product from swaying or falling, you can install brackets accordingly.

1. Loosen the screw on the left and right at the bottom rear of the product as shown in the picture below
2. Install the bracket on the left and right side
3. Make a hole on the surface where the product is installed
4. Fix the bracket with screw
5. Tighten the screw

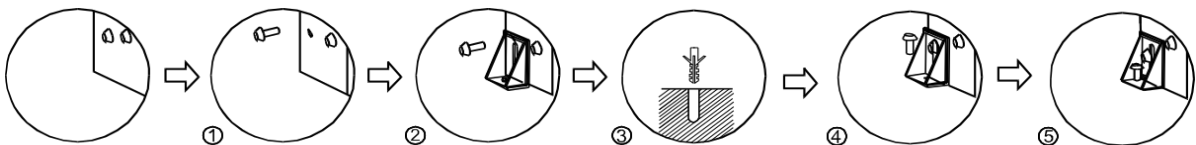
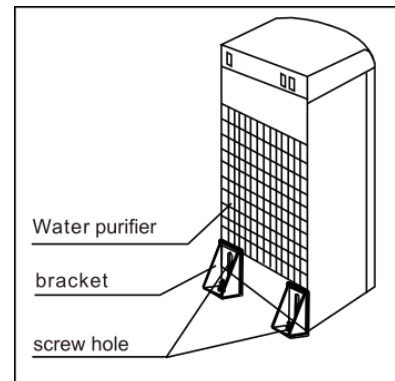

ATTENTION!

1. This product is designed for indoor use only
2. Ensure that the filters and pipes are properly installed and the door is **tightly** closed
3. Avoid installing the product on a damp, wet area, and on places with bad electrical installation. This can result in electrical shock and fire.
4. Do not place flammable materials near the product
5. Do not place the product under direct sunlight or rain because it can reduce product performance and electrical hazard
6. Do not turn on the heating switch when there is no water inside the water tank or when there is no water running.
7. Do not modify or extend the power cord because it can cause short circuit and fire
8. Do not touch the back of the product or condenser to prevent electric shock

Part 3: How to Use

RO 9115 Control Panel:

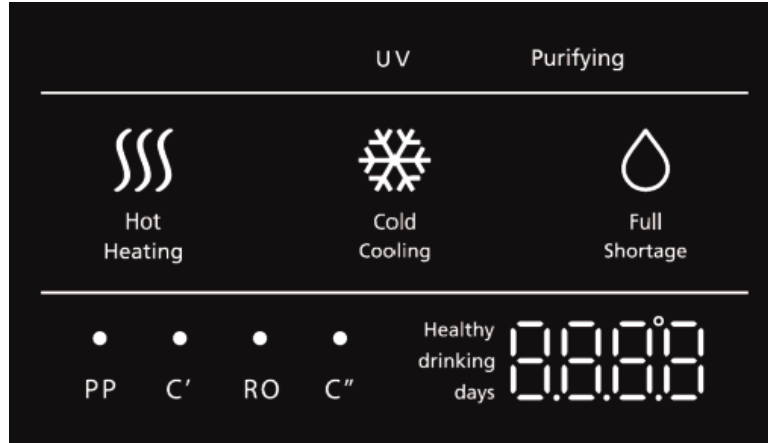







Remark	Description
UV	UV lamp inside the tank is operating
Purifying	Product is purifying the water
Hot	Heating process is complete
Heating	Heating process is in progress
Cold	Cooling process is complete
Cooling	Cooling process is in progress
Full	Water inside the tank is sufficient
Shortage	Water inside the tank is empty
PP / C' / RO / C''	If the lamp of each filters are blinking, the filter must be replaced
Healthy Drinking Days	Shows the amount of days since the product is turned on <i>To reset the count, turn of the product and disconnect it from the power source for ±2 weeks</i>









How to Use RO 9115:



1. Touch the cold water button (❄️), cold water will be dispensed and touch it again to stop dispensing
2. Touch the ambient water button (💧), normal water will be dispensed and touch it again to stop dispensing









3. Touch the child lock button , then touch the hot water button , hot water will be dispensed. Touch the hot water button again to stop dispensing
4. Touch the cold water button  and ambient water button  together for 3 seconds to enter the filter reset mode. Indicator lamp for the first filter will turn on and the percentage of filter life is displayed on the lower right of the display. Touch the cold water button  for 3 seconds to reset the filter and the filter life will reset to 100. Touch the cold water  button again to switch to another filter. Touch the cold water button  again to exit filter reset mode.

Display Panel RO 8115:









Remark	Description
 Heating Lamp	Lamp will turn on when heating process is in progress and will turn off when completed
 Cooling Lamp	Lamp will turn on when cooling process is in progress and will turn off when completed
 Filter Change Lamp	Lamp will blink/flash when the filter needs to be replaced. Contact the call center for filter replacement.
 Hot water button	Hot water selection button
 Cold water button	Cold water selection button
 Big volume button	Big volume select button Hot water: ±400 mL / Cold water: ±500 mL
 Small volume button	Small volume select button Hot water: ±200 mL / Cold water: ±250 mL
 Water button	Dispense water button

How to Use RO 8115:

Hot water

1. When heating lamp  is off, place the glass under the water tap
2. Touch the hot water button , then touch the water button  to dispense hot water. Touch the water button  again to stop dispensing
3. Touch the big volume button  and hot water button  to dispense hot water for ±400 mL
4. Touch the big volume button  and hot water button  to dispense hot water for ±200 mL

Cold water

1. When the cooling lamp  is off, place the glass under the water tap
2. Touch the cold water button , then touch the water button  to dispense cold water. Touch the water button  again to stop dispensing
3. Touch the big volume button  and cold water button  to dispense cold water for ±500 mL
4. Touch the small volume button  and cold water button  to dispense cold water for ±250 mL

RO 8101 Display Panel:

From top to bottom:

Lamp	Description
Heating	Lamp will turn on when heating process is in progress and will turn off when completed
Cooling	Lamp will turn on when cooling process is in progress and will turn off when completed
Filter Change	Lamp will blink/flash when the filter needs to be replaced. Contact the call center for filter replacement.

How to Use RO 8101

The buttons are located on top of the product.

1. Push the hot water button on the left to dispense hot water
2. Push the cold water button on the right to dispense cold water

Note: The middle button on model RO 8101 is not available to use

Part 4: Maintenance

1. For your safety, always disconnect the plug from the power source before maintenance, cleaning, and draining.
2. This product has been sterilized before leaving the factory
3. Pipes, water tanks, and heating elements need to be cleaned once a year. Contact the call center to schedule this maintenance. This will maintain the product in good condition and prolong its lifetime. Do not attempt to disassemble the product on your own to prevent unwanted damage.
4. Use a soft damp cloth to clean the surface. Use a soft dry cloth to dry. Do not let the water enter the product.
5. If the product will not be used for a long time, unplug the cable from the power socket and drain the water inside the water tank.
6. Do not use volatile chemical substances to clean the product.





Filter Replacement Cycle

Filter#1 PP	Filter#2 C1	Filter#3 RO	Filter#4 C2
6 months	6 months	12 months	12 months

Remarks:

- The data above is only for reference. The filter lifetime stated above is based on 10 L water consumption per day. The filter replacement cycle can vary according to the local water quality and actual water consumption.
- If you do not know which filter that needs to be replaced, please contact the call center to schedule filter replacement.

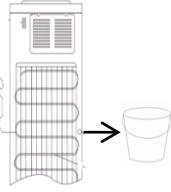
Part 5: Precaution Action

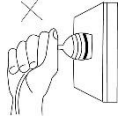
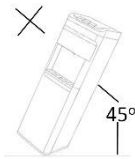
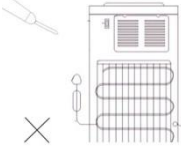
<p>a. Place the product in an even and stable surface. Avoid damp areas. Provide a minimum of 20 cm distance from the wall. Do not place flammable materials near the product</p>	
<p>b. To avoid damaging the product, do not connect the power or turn on the heating switch when the water tank is empty or when there is no water flow</p>	
<p>c. If the product will not be used for a long time, unplug the cable from the power socket and drain the waters inside the water tank.</p>	
<p>d. 6. Do not use volatile chemical substances to clean the product. Use a soft cloth to clean the product.</p>	
<p>e. Do not unplug by pulling the cable, pull the plug. Always unplug with dry hands</p>	
<p>f. Do not put the product horizontally and do not incline more than 45° angle to prevent damage to the compressors.</p>	
<p>g. The thermostat on the product has been adjusted from factory. Do not attempt to modify the thermostat to prevent damage</p>	

h. This product is designed for adults. Do not allow children to play with the appliance or let them hang on the door. The unit might fall and cause harm. The product is not intended for use by people with reduced physical, sensory, or mental capabilities or lack of experience with similar products unless given supervision or instruction concerning the use of the appliance by a qualified person.

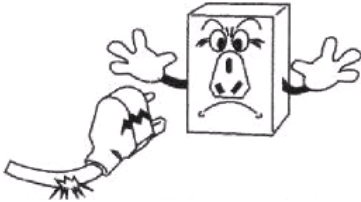

If there is damage to the power cord immediately contact the MODENA call center for replacement. Replacing the power cord must be done by personnel with experience and understanding of electricity. Never replace the power cord by yourself, due to the dangers that could lead to harm to you and the others.

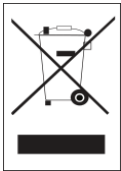

Attention!

- This symbol indicates that waste electrical and electronic products (WEEE) should be disposed of separately from the municipal waste stream.
- Old electrical products can contain hazardous substances. Thus, correct disposal of your old appliance will help to prevent potential negative consequences for the environment and human health. Your old appliance may contain reusable parts that could be used to repair other products, and other valuable materials that can be recycled to conserve limited resources.
- You can take your appliance either to the shop where you purchased the product, or contact your local government waste office for details of your nearest authorized WEEE collection point.

Part 6: Problem & Solution

Please inspect the following problem and symptoms before contacting the call center:

Problem	Possible Cause	Recommended Action
Water is not hot nor cold	<ul style="list-style-type: none"> • Excessive use of hot/cold water during short period of time • Product is unplugged 	<ul style="list-style-type: none"> • Wait until the heating/cooling process is complete • Plug the cable to the power socket
Water is not dispensed from water tap	<ul style="list-style-type: none"> • Low water pressure • Filter is not replaced, beyond the service time 	<ul style="list-style-type: none"> • Check booster pump or water inlet • Please contact the call center for filter replacement
Water leakage	<ul style="list-style-type: none"> • Pipe not connected properly • Water pipe/PE pipe breaks 	<ul style="list-style-type: none"> • Check the pipe for proper connection • Replace the PE pipe
*RO 8115 “  ” lamp flashes *RO 8101, all 4 lamps flashes	<ul style="list-style-type: none"> • PCB error 	<ul style="list-style-type: none"> • Contact the call center • Check the PCB on the base plate. Repair the machine/dry the PCB and then turn it on again
Loud noise	<ul style="list-style-type: none"> • Improper placement or installation 	<ul style="list-style-type: none"> • Install on a flat and stable surface
*RO 9115 Display E0	<ul style="list-style-type: none"> • Water leakage 	<ul style="list-style-type: none"> • Contact the call center
*RO 9115 Display Ec, Ed	<ul style="list-style-type: none"> • Water level switch failure 	<ul style="list-style-type: none"> • Contact the call center
*RO 9115 Display Fc, E7	<ul style="list-style-type: none"> • Abnormal heating function • Abnormal temperature sensor 	<ul style="list-style-type: none"> • Contact the call center
*RO 9115 Display E6 “	<ul style="list-style-type: none"> • Water pressure is too low • Filters needs replacement 	<ul style="list-style-type: none"> • Contact the call center

Part 7: Specification

MODEL	RO 8101	RO 8115	RO 9115
Type	Hot & Cold	Hot & Cold	Hot, Normal & Cold
Lower compartment	Filter storage	Filter storage	Filter storage
Color	Black	Black	White
Hot water output (Liter/hour)	4	4	7.5
Cold water output(Liter/hour)	2	2	4
Hot water capacity (Liter)	1.16	1.16	2
Cold water capacity (Liter)	3.6	3.6	5
High temperature (°C)	≥90	≥90	≥85
Cold temperature (°C)	≤10	≤10	≤10
CFC Free compressor	Yes	Yes	Yes
Thermostat	Yes	Yes	Yes
Water tank material	SUS 304	SUS 304	SUS 304
Heating Power Input (Watt)	384	384	874
Cooling Power Input (Watt)	100	100	120
Product Dimension (L x W x H) mm	310 x 370 x 1040	310 x 370 x 1050	360 x 460 x 1400
Product weight (Kg)	18	19	31.5

** Specifications of this appliance may change without notice to improve the quality of the product. The pictures in this manual are schematic and may not exactly match your product. Values stated on the machine labels or in the documentation accompanying it are obtained in laboratory in accordance with the relevant standards. Depending on operational and environmental conditions of the appliance, values may vary*

